



INDOOR RESIDUAL SPRAYING

AN OPERATIONAL MANUAL
FOR INDOOR RESIDUAL SPRAYING
(IRS) FOR MALARIA TRANSMISSION
CONTROL AND ELIMINATION

SECOND EDITION



**World Health
Organization**

Indoor Residual Spraying

AN OPERATIONAL MANUAL FOR
INDOOR RESIDUAL SPRAYING (IRS)
FOR MALARIA TRANSMISSION
CONTROL AND ELIMINATION

SECOND EDITION



World Health
Organization

WHO Library Cataloguing-in-Publication Data

Indoor residual spraying: an operational manual for indoor residual spraying (IRS) for malaria transmission control and elimination – 2nd ed.

1. Malaria – prevention and control. 2. Insecticides – administration and dosage.
3. Mosquito Control – methods. 4. Handbooks. I. World Health Organization.

ISBN 978 92 4 150894 0

(NLM classification: WC 765)

© World Health Organization 2015

All rights reserved. Publications of the World Health Organization are available on the WHO website (www.who.int) or can be purchased from WHO Press, World Health Organization, 20 Avenue Appia, 1211 Geneva 27, Switzerland (tel.: +41 22 791 3264; fax: +41 22 791 4857; e-mail: bookorders@who.int).

Requests for permission to reproduce or translate WHO publications –whether for sale or for non-commercial distribution– should be addressed to WHO Press through the WHO website (www.who.int/about/licensing/copyright_form/en/index.html).

The designations employed and the presentation of the material in this publication do not imply the expression of any opinion whatsoever on the part of the World Health Organization concerning the legal status of any country, territory, city or area or of its authorities, or concerning the delimitation of its frontiers or boundaries. Dotted and dashed lines on maps represent approximate border lines for which there may not yet be full agreement.

The mention of specific companies or of certain manufacturers' products does not imply that they are endorsed or recommended by the World Health Organization in preference to others of a similar nature that are not mentioned. Errors and omissions excepted, the names of proprietary products are distinguished by initial capital letters.

All reasonable precautions have been taken by the World Health Organization to verify the information contained in this publication. However, the published material is being distributed without warranty of any kind, either expressed or implied. The responsibility for the interpretation and use of the material lies with the reader. In no event shall the World Health Organization be liable for damages arising from its use.

Printed in Switzerland

First edition published in April 2013

Second edition published in June 2015

Contents

Acknowledgements	iv
Abbreviations	v
Chapter 1 Indoor residual spraying (IRS) policy and strategy	1
1.1 Introduction	3
1.2 Defining IRS	4
1.3 Objectives and outcomes of IRS	7
1.4 Selection of areas for IRS	8
1.5 When to use IRS	12
1.6 References and web links	13
Chapter 2 Management of an IRS programme	15
2.1 Introduction	17
2.2 Gathering baseline information	17
2.3 Selection of insecticides	23
2.4 IRS application equipment: hand-operated compression air sprayers	38
2.5 Organization and delivery of IRS campaigns	41
2.6 Information, education and communication; and community mobilization	56
2.7 Reporting on progress and performance	58
2.8 Review of annual operations	64
2.9 References and web links	65
Chapter 3 Conducting a house spray	67
3.1 Conducting a house spray	69
3.2 Spray equipment inventory and maintenance	79
3.3 Human safety and environmental protection	82
3.4 Spray application supervision	85
3.5 Important health and environmental safeguards necessary for IRS operations	86
3.6 References and web links	86
Useful resources and web links	87
Annex 1 IRS checklists and forms	93
A1.1 Example of sprayable surface record form for baseline estimation of insecticide quantification needs	95
A1.2 Example of house spray card	96
A1.3 Example of annual reporting on insecticides used for vector control	97
A1.4 Timeline for implementation of IRS	98
A1.5 Example of capital and operational budgets for an IRS campaign	100
A1.6 Code of conduct	101
A1.7 Examples of IRS operations organizational charts	103
A1.8 Example of daily reporting form for spray operators	105
A1.9 Example of daily/weekly reporting form for spray team leaders	106
A1.10 Example of monthly reporting form for district IRS coordinators	107
A1.11 Example of checklist for cleaning the sprayer in the field	108
A1.12 Example of checklist for maintenance of sprayers	109
A1.13 Example of spray team leader and IRS supervisor's checklist	110
A1.14 Example of IRS supervision inspection checklist	111

Acknowledgements

This operational manual is based on extensive contributions from a working group on indoor residual spraying (IRS) comprising: Birkinsh Ameneshewa, Chang Moh Seng, John Chimumbwa, Christian Frederickson, John Govere, Jeffrey Hii, Manuel Lluberas, Michael Macdonald, Shiva Murugasampillay, Natacha Protopopoff and Lucien Swillen. Valuable inputs were received from Marc Coosemans, Dereje Dengela, Jonathan Lines, Abraham Mnzava, Robert Newman, Chusak Prasittisuk and Morteza Zaim. The revision of this manual was completed by Emmanuel A Temu, Graham A Matthews, Evan W Thornhill and Abraham P Mnzava, with input from country programmes. The document was edited by Alison Clements-Hunt, copy edited by Hilary Cadman, designed by Sue Hobbs and illustrations redrawn by Adele Jackson.

The manual aims to fill the gap that currently exists in the availability of technical and practical information related to the current scaling up of IRS for malaria control and elimination. It brings together the knowledge of a number of senior contributors with decades of fieldwork behind them, and supplements this with peer reviews from an extensive list of distinguished contributors and collaborators. Though comprehensive, this manual is not intended to replace field expertise in IRS. It has been created to enhance existing knowledge and skills, and to assist malaria programme managers, entomologists, and vector-control and public health officers to design, implement and sustain high-quality IRS programmes.

This second edition incorporates an IRS supervision inspection checklist for environmental and human toxicology compliance, an updated list of WHO recommended products for IRS and the requirements for control flow valve (CFV) equipment. The manual emphasizes the importance of using equipment which complies with WHO specifications, in particular the use of the correct nozzle and CFV on compression sprayers, and provides guidance on specific spraying challenges, such as how to spray houses that do not have an internal ceiling, but a high roof. The manual has been updated to ensure that all technical content is aligned with current WHO technical recommendation, also information on specification for soak pits and evaporation tanks, in addition, important health and environmental safeguards have been included. The document was finalized with support from the WHO Collaborating Centre for the Testing of Insecticide Application Equipment, International Pesticide Application Research Centre (IPARC), Imperial College, UK.

Abbreviations

a.i.	Active ingredient
ACT	Artemisinin-based combination therapy
API	Annual parasite incidence
CDC	Centers for Disease Control and Prevention
CFV	Control flow valve
CS	Capsulated suspension
EC	Emulsifiable concentrate
EIR	Entomological inoculation rate
DDT	Dichlorodiphenyltrichloroethane
DHS	Demographic health survey
FAO	Food and Agriculture Organization of the United Nations
GIS	Geographic information system
GMAP	Global Malaria Action Plan
GMP	Global Malaria Programme
GPIRM	Global Plan for Insecticide Resistance Management in malaria vectors
GPS	Global positioning system
GR	Geographical reconnaissance
IEC	Information, education and communication
IRS	Indoor residual spraying
ITN	Insecticide-treated mosquito net
IVM	Integrated vector management
LLIN	Long-lasting insecticidal net
LSM	Larval source management
m ²	Square metre of surface
MDG	Millennium Development Goal
MSDS	Material Safety Data Sheets
NGO	Nongovernmental organization
PC	Personal computer
PDA	Personal digital assistant
POA	Plan of action
PP	Parasite prevalence
PPE	Personal protective equipment
RBM	Roll Back Malaria Partnership
SC	Suspension concentrates
SC-PE	Polymer-enhanced suspension concentrate
UNEP	United Nations Environment Programme
US	United States
WG	Water-dispersible granules
WHO	World Health Organization
WHOPES	WHO Pesticide Evaluation Scheme
WP	Wettable powder

CHAPTER 1



Indoor residual spraying (IRS) policy and strategy

Contents

1.1	Introduction	3
1.2	Defining IRS	4
1.2.1	IRS in the context of integrated vector management	5
1.2.2	IRS and insecticide-resistance management	5
1.2.3	IRS combined with long-lasting insecticidal nets	6
1.2.4	IRS combined with larval source management	7
1.3	Objectives and outcomes of IRS	7
1.3.1	Objectives of IRS	7
1.3.2	Outcomes of IRS	7
1.4	Selection of areas for IRS	8
1.4.1	Entomological determinants	8
1.4.2	Epidemiological determinants	9
1.4.3	Ecological determinants	10
1.4.4	Environmental safety determinants	10
1.4.5	Demographic and socioeconomic determinants	11
1.4.6	Health services determinants	11
1.5	When to use IRS	12
1.6	References and web links	13

1.1 Introduction

Vector control is the key intervention for global malaria control and elimination efforts. It is critical for the reduction and, ultimately, for the interruption of malaria transmission. Currently, the two most common vector control interventions are long-lasting insecticidal nets (LLINs) and indoor residual spraying (IRS). Together, these account for almost 60% of global investment in malaria control (1).

The number of LLINs delivered by manufacturers has increased dramatically in recent years, rising from 5.6 million in 2004 to 145 million in 2010 in sub-Saharan Africa. Nearly 300 million LLINs were delivered to African countries between 2008 and the end of 2010. Meanwhile, the number of people protected by IRS in the WHO African Region increased from 10 million in 2005 to 78 million in 2010. In total, 185 million people were protected by IRS in 2010, representing 6% of the global population at risk (2). In 2013, 124 million people were protected by IRS, representing 4% of the global population at risk (3).

These investments are now demonstrating returns. During the past decade, malaria mortality rates have declined by 25% globally, and by more than 33% in the WHO African Region. But the estimated number of deaths worldwide is still too high for a disease that is entirely preventable and treatable. In 2010 there were an estimated 660 000 deaths (range 490 000–836 000) from malaria. An estimated 81% of cases and 91% of these deaths occurred in the WHO African Region and, globally, 86% of the victims were children under 5 years of age. In the same year, an estimated 219 million cases of malaria (range 154–289 million) occurred in 99 countries and territories around the world.

IRS can contribute to the elimination of malaria if rigorously applied. Historically, malaria was controlled by draining areas of standing water near habitations and using screens to prevent mosquitoes from entering living areas. But the tremendous accomplishments of malaria programmes in Europe, Asia and the Americas, which resulted in hundreds of millions of lives being saved between the 1940s and the 1980s, was largely due to the addition of IRS as a vector-control intervention. More recently, the scale-up of IRS in Africa has contributed, together with LLINs and improved diagnostic testing and treatment, to remarkable declines in malaria burden and all-cause childhood mortality. IRS is highly effective when properly applied, but it requires adequate national programme capacity, structures and systems.

The IRS management cycle, described below, requires detailed and rigorous planning, management and supervision. It also has a significant entomological and epidemiological monitoring component. The basic techniques (i.e. how one plans and implements a spray campaign) have remained more or less the same for decades. However, the strategy around IRS management and the context in which it is deployed has changed tremendously in recent years. These changes include: the role of IRS in the context of universal LLIN coverage; the role of IRS in insecticide-resistance management; and the reorientation of many national malaria control programmes towards an integrated vector management (IVM) approach. Effective IRS operations require:

- adequate political commitment and social acceptance of IRS;
- adequate programme and health system capacity to deliver good-quality, well-timed and high-coverage IRS;
- adequate information on local vectors, especially insecticide susceptibility status and indoor versus outdoor feeding and resting behaviours;
- adequate and sustainable financial, logistical and human resources; and
- an IVM platform, which is also relevant for insecticide-resistance management where insecticides with different modes of action can be rotated to reduce selection for resistance.¹

¹ Global Plan for Insecticide Resistance Management in malaria vectors, Pillar I
http://whqlibdoc.who.int/publications/2012/9789241564472_eng.pdf

Use of the manual

The purpose of this manual is to provide up-to-date information on IRS operations, to outline current WHO standards on IRS intervention, and to offer step-by-step guidance on the overall management of an IRS programme together with practical steps on household spray application. This manual will enable national programmes to:

- develop or refine policies and strategies
- develop or update existing guidelines
- develop or update existing training materials
- review access and coverage of IRS programmes
- review the quality and impact of IRS programmes.

The manual is designed to focus on the management of a safe and effective IRS programme and to help managers and policy-makers make the most effective possible use of an IRS strategy within the context of a comprehensive malaria control programme.

The manual is divided into three chapters:

- 1) IRS policy, strategy and standards for national policy-makers and programme managers
- 2) IRS management, including stewardship and safe use of insecticides, for both national programme managers and district IRS coordinators
- 3) IRS spray application guidelines, primarily for district IRS coordinators, supervisors and team leaders.

To maximize its impact, it is recommended that the manual be translated into other languages relevant to malaria-endemic countries.

1.2 Defining IRS

IRS is the application of a long-lasting, residual insecticide to potential malaria vector resting surfaces such as internal walls, eaves and ceilings of all houses or structures (including domestic animal shelters) where such vectors might come into contact with the insecticide.

When carried out correctly, IRS is a powerful intervention to rapidly reduce adult mosquito vector density and longevity and, therefore, to reduce malaria transmission. The effectiveness of IRS as a malaria control intervention arises from the fact that many important malaria vectors are endophilic.¹ That is, when searching for blood meals they enter human habitations or animal shelters where they rest on the walls, ceilings and other interior surfaces before or after feeding on the residents. When a vector comes into contact with a sprayed surface, it absorbs a lethal dose of insecticide, thereby reducing its lifespan. This results in a progressive decline in vector density and longevity, especially among older female mosquitoes, and a reduction in overall vectorial capacity, thereby contributing to a reduction in malaria transmission. IRS is most effective against indoor feeding (endophagic) and indoor-resting (endophilic) vectors. IRS was the primary malaria control method used during the Global Malaria Eradication Campaign (1955–1969). The campaign did not achieve its stated objective, but 37 of the 143 countries that were endemic in 1950 were free of malaria by 1978 and there was a sharp reduction in the burden of disease in other countries (4).

One significant difference between the use of IRS and the use of treated mosquito nets is the point at which each intervention works to greatest effect. IRS may provide some small amount of protection to an individual house by repelling and reducing the number of vectors that come *into* the house. However, the greatest impact of an IRS intervention takes place *after* feeding, when the anopheline mosquito is more likely to rest on a sprayed surface and pick up a lethal

¹ Endophilic: tends to rest indoors. Exophilic: tends to rest outdoors.
Endophagic: tends to bite indoors. Exophagic: tends to bite outdoors.

dose of insecticide, thus preventing it from going on to transmit the malaria parasite to others in the vicinity. This means that for IRS to be effective, there must be high coverage¹ (usually > 85%) of all structures that are potential resting places in order to obtain the “mass effect” on the vector population: in other words, being the only sprayed house in the neighbourhood will do little to protect the residents. LLINs, however, inhibit feeding *before* the mosquito can inoculate the person with sporozoites, and insecticide component of net provide a degree of lethal effect on the vector. This provides both personal protection and, at high coverage rates, a “mass effect” on the vector population. Therefore, being the only house in the neighbourhood with residents sleeping under a treated net *will* provide some degree of protection, even if the neighbours are not covered.

1.2.1 IRS in the context of integrated vector management

National ministries of health and their partners, including private-sector workplace protection programmes, should plan IRS in the context of a broader malaria control effort. The approach should be adapted to the specific challenges and opportunities presented by the country’s individual ecological situation and within the context of its national malaria control programme. IVM provides a framework within which these strategic challenges and opportunities can be addressed.

IVM is defined as “a rational decision-making process for the optimal use of resources for vector control” (5). The approach seeks to improve the efficacy, cost-effectiveness, ecological soundness and sustainability of disease vector-control. IVM is not simply throwing multiple interventions together, nor is it a separate programme. Rather, it is a management approach that enables vector-control efforts to be adapted, broadened, optimally deployed and sustained.

The Global Strategic Framework for IVM identifies five key elements for successful implementation. These are listed in Table 1 below, with examples of how they can frame the IRS programme strategy.

1.2.2 IRS and insecticide resistance management

Insecticide resistance is a major challenge to global malaria control efforts, especially in Africa and the India subcontinent. WHO and its partners have developed a Global Plan for Insecticide Resistance Management in malaria vectors (GPIRM) (6), and this should form the basis of any national vector-control strategy, including the use of IRS. Fundamental to the plan is the building of capacity and systems for basic epidemiological and entomological monitoring, including bioassays for insecticide susceptibility of the local vector populations. This information, together with information on local transmission ecology and epidemiology (e.g. length of transmission season and levels of transmission) will determine the appropriate selection of insecticides in order to mitigate or delay the further development of resistance. This is particularly important for the pyrethroids, the only class of insecticide that can be used on nets. As outlined in the GPIRM, pyrethroids need to be “protected” through judicious use and through rotation among the four classes of insecticide that can be used for IRS.

¹ “High coverage” is generally taken to mean that a high proportion (>85%) of the structures in a targeted area have been sprayed.

TABLE 1
Applying IRS within the IVM framework

IVM ELEMENT	APPLICATION TO IRS OPERATIONS
Advocacy, social mobilization and legislation	• Ensure adequate, up-to-date national insecticide and application equipment legislation and regulatory mechanisms to ensure safe and judicious use
	• If possible, coordinate with the ministry of agriculture on the use of pesticides, especially on those with a mode of action similar to the pesticides used in IRS (e.g. pyrethroids)
	• Reduce taxes and tariffs on commodities used for IRS
	• Ensure that IRS advocacy and communications effectively target policy makers, implementers, communities and other stakeholders
Collaboration within the health sector and with other sectors	• Establish partnerships with private-sector IRS operations for joint training, entomological monitoring and insecticide selection
	• Establish technical support linkages with insecticide and application equipment manufacturers and distributors
	• Establish partnerships with the ministry of agriculture and ministry of environment for supervision and pesticide management
Capacity building	• Identify the range of skills, competencies and staffing levels necessary for effective IRS operations
	• Ensure adequate human resource capacity by establishing training for spray operators and warehouse managers, and for entomological and epidemiological monitoring
	• Establish the requisite infrastructure for IRS including insectaries, entomology laboratories, warehouses, and waste disposal systems
	• Establish IRS recording and reporting methods and procedures, as well as vector-control information systems
Evidence-based decision-making	• Clarify information needs, IRS indicators and data collection methods
	• Establish entomological and epidemiological monitoring plans to help target and evaluate interventions
	• Select insecticides based on local data regarding vector susceptibility and transmission ecology especially with regards to the duration of malaria transmission seasons
	• Ensure insecticide selection is based on an insecticide-resistance management plan as outlined in the GPIRM
	• Ensure IRS and vector data collection are completed in a timely and rigorous manner
	• Manage and utilize evidence for decisions on IRS implementation and strategy refinement, including annual reassessment of targeted spray areas
Integrated approach	• Ensure there is adequate, evidence-based guidance on combining IRS with LLINs and other malaria control interventions
	• Evaluate whether IRS is having an impact on other vector-borne diseases
	• Explore additional complementary malaria vector control measures where they may be appropriate.

1.2.3 IRS combined with long-lasting insecticidal nets

Generally, the resources available for vector control are not sufficient to justify the routine combining of IRS with LLINs. However, there are specific situations in which such combinations may be justified for targeted areas. National malaria control programmes may consider using an IRS–LLIN combination for the following purposes:

- *As a response to identified pyrethroid resistance in settings where LLINs remain the dominant vector control method.* In such cases, as outlined in the GPIRM, focal IRS with a non-pyrethroid insecticide should be introduced, preferably through annual rotations of different classes of insecticide with different biochemical mode of action. Best practice is to do this in all areas of resistance; good practice is to do it at least in the areas of greatest concern. There is currently no evidence that adding IRS on top of LLINs provides an additional impact. The recommendation

is therefore to prioritize delivering one intervention at high coverage and to a high standard rather than introducing the second intervention as a means to compensate for deficiencies in the implementation of the first (7, 8).

- *As a “safety net” for IRS programmes in highly endemic areas.* Programmes may consider introducing LLINs as an adjunct to IRS in highly endemic areas to guard against a sudden collapse in vector control. A sudden halt to IRS could be due to problems associated with insecticide procurement, labour costs, fuel and transport problems, or social instability. In such cases, the sudden interruption of IRS operations may result in a rebound in the vector population and in malaria transmission, leading to a potential upsurge of malaria in the community, with significant adult illness and deaths
- *As a transition strategy.* As programmes move towards malaria elimination, transmission becomes focal. In such situations, the use of focal IRS becomes more appropriate. Improved entomological and disease surveillance is critical in identifying the transmission foci. This “road to elimination” is outlined in a number of WHO manuals (9).

1.2.4 IRS combined with larval source management

Larval source management (LSM) for malaria vector control is not applicable in many ecological and programme situations; therefore, it should be approached judiciously with appropriate entomological and epidemiological monitoring capacity and infrastructure in place. Larviciding should be rigorously evaluated to ensure that appropriate and good-quality vector control products are being used, and that it is being deployed where it can have the maximum impact on transmission. There may, however, be specific situations, where the vector breeding sites are few, fixed and findable, in which LSM could be considered as an adjunct to the IRS programme as outlined in the WHO position statement on larviciding (10).

1.3 Objectives and outcomes of IRS

1.3.1 Objectives of IRS

The objectives of IRS are to reduce, and ultimately interrupt, malaria transmission by reducing vector survivorship, density, and human–vector contact, in a manner that is safe for human health and the environment. Specific objectives are as follows.

- *To reduce the vector’s lifespan* to less than the time it takes for the malaria sporozoites to develop. In this way the vector can no longer transmit malaria parasites from one person to another.
- *To reduce vector density* by immediate killing. In some situations, particularly with *Anopheles funestus*, IRS can lead to the local elimination of important malaria vectors.
- *To reduce human–vector contact* through a repellent effect, thereby reducing the number of mosquitoes that enter sprayed rooms.

1.3.2 Outcomes of IRS

When applied properly, IRS is a powerful malaria vector control intervention, rapidly reducing vector-transmission capacity and malaria incidence. IRS provides maximum mass effect on the vector populations when it is applied at high coverage levels.

1.4 Selection of areas for IRS

The selection of areas for IRS must take into account the relationship between the vector, humans and the environment, as well as the level of disease transmission in the area under consideration.

Applying IRS in a targeted manner is critical, and programme managers will need to make strategic decisions about where IRS should be deployed in relation to transmission ecology, malaria endemicity, cost and logistics. The possibility of combining the intervention with other vector-control measures, especially LLINs, should also be considered.

- In low- and moderate-transmission areas, IRS is used as a primary vector-control intervention to reduce the seasonal annual peaks of malaria transmission, to prevent epidemics and to support malaria elimination.
- In high-transmission areas, IRS can be used to rapidly bring malaria transmission down to a level that can subsequently be sustained through a high proportion of the population using LLINs.
- In areas of significant economic importance (e.g. areas with large development projects such as industries, oil refineries, mines, irrigation and agro-forestry schemes), targeted IRS can be carried out to mitigate the impact of malaria on economic development.
- IRS has been used in some urban situations. However, it is important to take into account the biting behaviour of the vector and the actual level of malaria transmission relative to the costs of spraying a large number of structures.

Before the era of treated mosquito nets and improved diagnostics and mapping, malaria eradication strategies recommended IRS in all areas with an annual parasite incidence (API) of greater than 5/1000 and a parasite prevalence (PP) of greater than 1%. As malaria transmission was reduced, IRS became more selective and only targeted areas with an API of more than 2/1000. The current malaria elimination strategy, however, does not provide an absolute API or prevalence threshold above which IRS should be implemented and below which it should be halted. The decision to halt IRS in a particular area and “graduate” to a more surveillance-driven programme is context-specific. It depends on the malaria situation and the objective of IRS (i.e. whether it is intended to eliminate malaria or reduce transmission); vector susceptibility to pesticides; vector behaviour and competence; the receptivity and vulnerability of the various transmission foci; the sensitivity of the surveillance system to detect cases; and the effectiveness of the control programme to respond to a reintroduction of cases. The API figures provided in Table 2 below are designed to serve as a general guide only; the final decision on whether to deploy or withdraw IRS depends on a number of other factors:

- entomological
- epidemiological
- ecological
- environmental
- demographic and socioeconomic
- health service.

1.4.1 Entomological determinants

The key entomological determinants are:

- vector species
- seasonal density and distribution of the vector(s)
- resting and feeding behaviour of the vector(s)
- insecticide susceptibility status.

A preliminary study must be carried out to identify the primary and secondary (if any) vector species responsible for malaria transmission in a given area. It is important to remember that vector genetic diversity may coincide with important biological characteristics such as insecticide resistance. In order for IRS to be applied before the peak transmission period, which usually occurs before the onset of the rains, seasonal changes in vector density and transmission potential need to be established.

Accurate information regarding the resting and feeding behaviour of the local vectors must be gathered and fully documented before selecting IRS as an intervention.

A basic entomological monitoring plan must also be established. Basic entomological indicators and methods of assessment, as well as training materials, are available from WHO and can be found on the Global Malaria Programme (GMP) website. In addition to vector identification, feeding and resting behaviours and insecticide susceptibility status, programmes should also monitor the duration and effectiveness of IRS application. Currently this is done through the standard WHO “cone bioassay”; however, new colorimetric assays that do not require a colony of susceptible mosquitoes are under development.

Insecticide resistance is the most critical challenge currently facing global malaria vector control efforts, and is central to the planning and implementation of an effective IRS programme. As outlined in the GPIRM, the insecticide-resistance status of local vectors must be determined before selecting the insecticides to be used in an IRS programme.

IRS is particularly effective in areas where the vectors have a strong preference for feeding and resting indoors (i.e. are endophagic and endophilic). Some vectors that feed indoors but tend to rest outdoors (exophilic) can also be controlled if they rest, even very briefly, after feeding and before exiting the house. Likewise, there are situations where the human population tends to sleep outdoors at night, but where the vector rests indoors during the day in houses or cattle sheds, and can thus be controlled by IRS. There are however, some situations where the vector is strongly exophagic and exophilic, both feeding and resting outdoors, and rarely comes into contact with an indoor wall surface. In these cases IRS may not be suitable.

1.4.2 Epidemiological determinants

The key indicators of malaria endemicity are:

- *parasite prevalence (PP)* – gathered through cross-sectional population-based surveys; and
- *parasite incidence* – usually gathered passively through facility-based records and calculated monthly or annually. Traditionally this has been expressed as the API, and calculated as the number of new parasitologically confirmed cases per 1000 population per year (11).

Malaria transmission and epidemiology vary both within and between countries. Different areas may require different interventions or combinations of interventions. IRS can be implemented in all eco-epidemiological settings as long as conditions for effective implementation and maintenance of the programme are met. However, shorter transmission seasons (where insecticides with shorter residual efficacy can be used) and more densely spaced housing (where transportation needs are less) favour IRS. Areas with perennial transmission (where two rounds of spray per year may be required) and widely dispersed housing (where transportation and labour costs will be higher) may favour the use of LLINs. IRS programmes in different epidemiological settings can have different objectives, including the following:

- *in unstable and seasonal transmission areas* – to eliminate or reduce the seasonal peak, prevent epidemics and, if detected at an early stage, to control epidemics;
- *in perennial transmission areas with distinct seasonal increase* – to suppress seasonal peaks, and to reduce overall malaria transmission; and

- *in stable and perennial transmission areas* – to reduce transmission rapidly, generally followed by sustained vector control through the use of LLINs.

In all settings, vector control must be combined with diagnostic and treatment services as outlined by WHO in its *T3: Test. Treat. Track Initiative* (12). Malaria-endemic countries should ensure that every suspected malaria case is tested, that every confirmed case is treated with a quality-assured antimalarial medicine, and that the disease is tracked through timely and accurate surveillance systems to guide policy and operational decisions.

In the “attack phase” of malaria control, as programmes scale up coverage to all malaria risk populations, IRS is conducted in targeted areas, usually for a period of 3–5 years. In the consolidation, maintenance, pre-elimination and elimination phases, IRS is used more selectively, based on malaria surveillance, and is targeted towards locations where there are residual malaria foci and where there is re-establishment or a resurgence of transmission.

In countries where IRS has not been implemented, pilot implementation should generally precede the attack phase (Table 2).

TABLE 2
IRS in phases of malaria control and elimination

PHASE	ACTIVITIES	TRANSMISSION	IRS OPERATIONS
Preparatory phase	■ Survey (geographical reconnaissance [GR], mapping, epidemiological, entomological)	API >5/1000 PP > 1%	Pilot IRS operations in selected areas
	■ Planning, organization, legislation, training and public education		
Attack phase	■ Surveillance and repeated surveys with generalized attack operations in all malaria areas	API >5/1000 PP > 1%	Total coverage IRS of all malaria risk areas for 3–5 years
	■ Evaluation of operations		
	■ Update GR and mapping		
Consolidation phase	■ Surveillance for 3 years	API <5/1000 PP <1%	Targeted IRS operations
	■ Update GR and mapping		
Maintenance phase	■ Surveillance	Sporadic cases	Focal IRS operations
	■ Update of GR and mapping		

1.4.3 Ecological determinants

There are a number of variables that largely determine the intensity of malaria transmission. These variables – which include topography, altitude, the presence of permanent water bodies, temperature, humidity (wet, dry and winter seasons) and rainfall (duration and intensity) – have an impact on vector bionomics and transmission dynamics.

1.4.4 Environmental safety determinants

Programmes should only use WHO Pesticide Evaluation Scheme (WHOPES) recommended chemicals and application equipment for IRS and these should comply with national and international regulatory and environmental safety standards. Detailed guides for good pesticide management, including procurement, quality control, transport, storage, use and disposal are available from WHO (13).

Agricultural practices, including certification for organic farming, export of pesticide-free crops, or practices such as silk-worm cultivation in Asia, need to be taken into account when selecting areas for IRS.

Consulting and achieving consensus with environmental agencies and agricultural ministries is vital. Many countries, programmes and implementing partners require environmental safety reviews to be carried out to ensure safe pesticide management and delivery of IRS. Programmes must ensure they comply with specific standards and procedures for pesticide storage, delivery, usage, stock control, recording and reporting.

1.4.5 Demographic and socioeconomic determinants

When selecting which zones are to be sprayed, population number, density and ease of access need to be taken into account. Poor or non-existent roads, widely dispersed housing, or the presence of physical barriers such as rivers and mountains can be major obstacles for spray teams trying to reach all settlements.

In order for IRS programmes to be successful, target structures must have suitable surfaces for treatment, and the correct insecticide formulations for those surfaces must be selected. Traditional housing made of mud, clay or wood requires different chemicals or formulations from modern houses that are made of brick or concrete and are usually painted. Total spraying of all suitable surfaces is required.

Settled populations that remain in one location for a good part of the year are more accessible than nomadic or mobile populations who migrate seasonally to fields or forests. The movements of people in and out of sprayed areas for the purpose of planting, harvesting, cattle grazing and other seasonal activities can result in temporary shelters being left unsprayed. These require special repeated follow-up (mop-up) spraying. “Incomplete houses” also pose a challenge for IRS as do those that are structurally “open” with few walls.

Social factors, such as the willingness of a community to accept IRS services and to cooperate with a spraying programme, are of critical importance when selecting areas for IRS. Sometimes households are receptive to IRS in the early stages when malaria and intense mosquito biting are perceived as problematic, but are less receptive when transmission has been reduced but not yet eliminated.

Cultural patterns in relation to housing must be considered. In some communities, outdoor sleeping is common in the hot and humid season, a time when mosquitoes are also abundant and active. Also, individual householders may re-plaster or whitewash walls, or re-thatch ceilings after spraying, thereby reducing vector exposure to the insecticide and making repeat spraying a necessity.

Areas of economic importance, such as irrigation schemes, mines and tourism centres, are a priority for IRS. High population density and economic viability mean they are priorities for protection from malaria. In addition, the populations that live in these areas usually comprise a mix of migrant workers from areas with different levels of malaria endemicity and immunity, including malaria-free areas. Such a mix creates situations conducive to epidemics.

IRS is also an appropriate vector-control method for the protection of camps for displaced persons or refugees, migrants, military personnel and sometimes construction workers. More information on malaria and vector control for refugee camps is available from WHO (14).

1.4.6 Health services determinants

Adequate health service capacity is important for the successful establishment of IRS programmes; hence, it is necessary to assess the status of the following elements:

- health policies to support vector control with IRS;
- health system organization at district, regional and national level to support an IRS programme;
- health financing for annual insecticides, equipment, transport and operational costs; and
- human resources capacity in vector control and entomology for planning and managing an IRS programme.

Ideally, IRS programmes are based on national financing and capacity-building, with the aim of long-term sustainability. The long-term costs of insecticides, spray application equipment, permanent IRS staff (including operations managers, field supervisors and seasonal temporary spray operators), as well as an annual operational budget, need to be estimated and planned for. Costs should be estimated both for initial pilot districts and for rapid roll out to cover all risk districts targeted for IRS.

The cost-benefit analysis of IRS is also an important determinant. Programmes must make rational resource-allocation decisions for the location and size of IRS operations in relation to other programme activities. Overall, the unit costs, considering all components (e.g. equipment, insecticides, labour operations and quality assurance activities) of large (>150 000 houses) programmes are less expensive than small (<150 000 houses) programmes, indicating that the cost per area sprayed is linked to programme scale; also that, even when using the most standardized comparison unit cost available, there is still no “one-price-fits-all” for IRS across countries (15). Furthermore, countries implementing IRS programmes are expected to rotate the class of insecticide used (from pyrethroid to carbamate to organophosphates) as a strategy to manage the increasing challenge of malaria vector resistance to insecticides, particularly pyrethroids. The type of insecticide class formulation for IRS may cause wide variation in country unit costs (15).

1.5 When to use IRS

The timing of IRS applications, or “rounds”, is a critical factor for a successful programme. Best practice is to schedule the completion of spray application to coincide with the build-up of vector populations just before the onset of the peak transmission season. This ensures fresh deposits of insecticides during periods of peak mosquito density. It is usually not operationally feasible to conduct more than two rounds of IRS in 1 year; ideally areas that can be protected with a single round of IRS per year are chosen. With timely, good-quality spraying, most recommended insecticides (particularly pyrethroids, a new organophosphate formulation, and dichlorodiphenyl-trichloroethane, DDT) are effective for 6 months or longer. With these insecticides, in the correct formulations, one round of effective spraying may be adequate to control malaria in most areas.

In summary, IRS is appropriate where:

- the majority of the vector population feeds and rests inside houses;
- the vectors are susceptible to the insecticide in use;
- people mainly sleep indoors at night;
- the malaria transmission pattern is such that the population can be protected by one or two rounds of IRS per year;
- the majority of structures are suitable for spraying; and
- structures are not scattered over a wide area, resulting in high transportation costs.

1.6 References and web links

1. Roll Back Malaria Partnership. Global Malaria Action Plan (GMAP). Geneva, 2008 (<http://www.rollbackmalaria.org/microsites/gmap/>, accessed 13 May 2015).
2. World Health Organization. World malaria report 2011. Geneva, 2011 (http://www.who.int/malaria/world_malaria_report_2011/en/index.html, accessed 3 January 2013).
3. World Health Organization. World malaria report 2013. Geneva, 2014 (http://www.who.int/malaria/publications/world_malaria_report_2013/en/, accessed 5 May 2015).
4. Wernsdorfer WH (1980) The importance of malaria in the world. In: Malaria Vol. 1 (ed JP Kreier) Academic Press, New York, pp. 1–93.
5. World Health Organization. Global strategic framework for integrated vector management. Geneva, 2004 (http://whqlibdoc.who.int/hq/2004/WHO_CDS_CPE_PVC_2004_10.pdf, accessed 3 January 2013).
6. World Health Organization. Global Plan for Insecticide Resistance Management in malaria vectors (GPIRM). Geneva, 2012 (http://www.who.int/malaria/vector_control/ivm/gpirm/en/index.html, accessed 3 January 2013).
7. WHO Review of current evidence on combining indoor residual spraying and long-lasting insecticidal nets (<http://www.who.int/malaria/mpac/background-combining-irs-llins-mar2014.pdf?ua=1>, accessed 13 May 2015)
8. WHO guidance for countries on combining indoor residual spraying and long-lasting insecticidal nets (http://www.who.int/malaria/publications/atoz/who-guidance-combining-irs_llins-mar2014.pdf?ua=1, accessed 13 May 2015)
9. World Health Organization. Malaria elimination: a field manual for low and moderate endemic countries. Geneva, 2007 (<http://www.who.int/malaria/publications/atoz/9789241596084/en/index.html>, accessed 3 January 2013).
10. World Health Organization. WHO interim position statement – the role of larviciding for malaria control in sub-Saharan Africa. Geneva, 2012 (http://www.who.int/malaria/publications/atoz/larviciding_position_statement/en, accessed 3 January 2013).
11. World Health Organization. Disease surveillance for malaria control: an operational manual. Geneva, 2012; World Health Organization. Disease surveillance for malaria elimination: an operational manual. Geneva, 2012 (<http://www.who.int/malaria/publications/atoz/9789241503334/en/>, accessed 13 May 2015).
12. World Health Organization. T3: Test. Treat. Track. Scaling up diagnostic testing, treatment and surveillance for malaria. Geneva, 2012 (http://www.who.int/malaria/publications/atoz/t3_brochure/en/, accessed 13 May 2015).
13. Technical guidance for management of public health pesticides – policy frameworks and guidelines. WHO Pesticide Evaluation Scheme (WHOPES) (http://www.who.int/whopes/recommendations/who_fao_guidelines/en/index.html, accessed 3 January 2013).

14. World Health Organization. Malaria control in complex emergencies: an inter-agency field handbook. Second edition. Geneva, 2013
(<http://www.who.int/malaria/publications/atoz/9789241548656/en/> , accessed 3 January 2013).
15. Presidents Malaria Initiative (PMI) IRS Country Programs: Comparative Cost Analysis, Years 1 and 2. December 2014. Bethesda, MD: Africa Indoor Residual Spraying (AIRS) Project, Abt Associates Inc.
(<http://www.pmi.gov/how-we-work/technical-areas/indoor-residual-spraying>, accessed 13 May 2015)

CHAPTER 2



Management of an IRS programme

Contents

2.1	Introduction	17
2.2	Gathering baseline information	17
2.2.1	Epidemiological baseline survey	17
2.2.2	Entomological (vector) baseline survey	18
2.2.3	Geographical reconnaissance and mapping of structures and households	18
2.2.4	Population census	21
2.2.5	Estimating number, size and type of structures or houses	22
2.3	Selection of insecticides	23
2.3.1	Type of action of insecticides	23
2.3.2	Characteristics of good residual insecticides	23
2.3.3	Classes and compounds of insecticides	24
2.3.4	WHO-recommended insecticides for IRS	26
2.3.5	Estimating insecticide requirements	28
2.3.6	Management of insecticides	29
2.3.7	Insecticide procurement and quality control	33
2.3.8	Insecticide use: annual reporting	35
2.3.9	Managing insecticide resistance	35
2.4	IRS application equipment: hand-operated compression air sprayers	38
2.4.1	Function, components and design	38
2.4.2	Hand-compression sprayers and spare or replacement parts	39
2.4.3	Personal protection equipment for spray operators	40
2.4.4	Inventory and maintenance of the equipment	41
2.5	Organization and delivery of IRS campaigns	41
2.5.1	Performance targets	41
2.5.2	Management cycle	41
2.5.3	Phases of an IRS campaign	42
2.5.4	Plan of action for operations	43
2.5.5	Financial planning for IRS	44
2.5.6	Costing, budgeting and financing	44
2.5.7	Checklist for tracking POA implementation	45
2.5.8	Timing and duration of spray rounds and cycles	45
2.5.9	Programme organization	46
2.5.10	Equipment and logistics for spray teams	54
2.5.11	Transport	54
2.5.12	Communication equipment	54
2.5.13	IRS field camps	54
2.5.14	Site consideration and specification of a soak pit	55
2.5.15	Evaporation tanks	55
2.6	Information, education and communication; and community mobilization	56
2.6.1	IRS advocacy	56
2.6.2	IEC campaigns	56
2.6.3	Community participation	57
2.7	Reporting on progress and performance	58
2.7.1	IRS programme performance	58
2.7.2	Methods of programme performance measurement	58
2.7.3	Routine operational performance indicators and performance targets	59
2.7.4	Evaluation of coverage, quality and impact	61
2.8	Review of annual operations	64
2.8.1	IRS programme operational review	64
2.8.2	IRS programme strategic review	64
2.9	References and web links	65

2.1 Introduction

Timely and good-quality delivery of IRS operations depends on strong programme leadership and a well-monitored management system. This includes collection of baseline information, detailed proposal development, thorough planning, rigorous implementation, strict supervision, careful monitoring and evaluation, and reporting. The planning and management cycle must take into account current epidemiological and entomological conditions. These should be reviewed annually, and IRS strategy adapted and optimized according to changing conditions.

Successful IRS campaigns require a high level of political commitment; dedicated human, logistic, transport and financial resources; and adequate organizational and planning capacity. The safety of spray operators, the community and the environment must also be ensured. In order to deliver IRS effectively, temporary field staff must be recruited, trained, motivated and retained; they also require back-up and supervision. While the spraying itself can be delivered by semiskilled but dedicated temporary field staff, the programme requires a well-trained core of skilled environmental or public health officers, field entomologists and epidemiologists, supported by programme managers. Timeliness is a key factor in obtaining maximum benefits from IRS; that is, the spray should be applied in the shortest period of time just prior to the onset of the transmission season.

Community awareness and support are other critical factors that influence the effectiveness of IRS programmes. Acceptance by the local population contributes to obtaining a high level of coverage, and this should be ensured by implementing community education and communication campaigns. Households should be well informed about the programme, and aware both of its benefits and of the necessary preparations required for a safe spraying campaign.

When introducing IRS in a country for the first time, it is best to start with one pilot area and then to expand the intervention out to other districts in each region or province. IRS should be started on a small scale, with measured annual increases allowing programmes to gain experience in developing the necessary operational capacities, infrastructure and systems for an efficient operation.

As there is a shortage of field-experienced IRS coordinators and supervisors, it is advisable when starting a new IRS programme to seek technical assistance from well-established programmes in other countries, or to engage private-sector expertise. As pilot districts scale up, IRS coordinators and supervisors will be able to support more districts in the planning and implementation of IRS.

In countries where IRS operations are ongoing, the focus should be on improving quality before any scale-up of coverage is considered. This should be accomplished through post-spray season reviews, which analyse timing of implementation, coverage, quality and impact on the disease. The information generated in a post-season review provides essential lessons for adapting and improving planning and management for the next season's spray operations.

2.2 Gathering baseline information

Baseline epidemiological, entomological and demographic data need to be assembled from desk reviews of health facility surveillance reports and from research studies and survey reports. This information should be regularly updated through rapid field assessments and geographical reconnaissance (GR).

2.2.1 Epidemiological baseline survey

Routine malaria surveillance data from health facilities should be accessed and tabulated by unit, by subdistrict and by district based on monthly and annual figures. API and malaria mortality rates should be calculated both in total and by age group with slide positivity rates (or test positivity rates

if the programme is using rapid diagnostic tests). Where feasible, and where sufficient financial and human resources are available, passive facility-based incidence data can be complemented by a community-based malaria prevalence survey.

Collection and analysis of parasitologically confirmed, facility-based malaria incidence data, complemented by community-based prevalence data when available, enables the district IRS coordinators to stratify their areas of operation by level of intensity of transmission. The epidemiological data should be correlated with the meteorological data, especially rainfall, for the previous 2–3 years. This will also provide guidance for prioritizing and limiting areas to spray, and identifying the best months for spraying and the number and timing of spray cycles required. Thresholds for stratification are set by the individual country based on epidemiology, geography, cost and available budgets. A key consideration is what is logistically practical. The thresholds and stratification are reviewed annually based on the latest data and feedback from the field.

Health facility incidence data and community-based prevalence data will also form the baseline from which the impact of IRS can be monitored and evaluated (1).

2.2.2 Entomological (vector) baseline survey

Entomological surveys provide essential information about the presence, distribution, behaviour, and insecticide susceptibility status of vectors in the target areas. The surveys are designed to gather both basic required information and additional complementary data.

Essential information

The following basic information needs to be regularly updated:

- identification of the anopheline vector species in the targeted areas;
- distribution and seasonality of the vector;
- indoor and outdoor resting habits of the anopheline vector; and
- insecticide susceptibility using the WHO tube assay or the Centers for Disease Control and Prevention (CDC) bottle assay (2).

Additional information

The following further information can be collected periodically and in collaboration with national research and academic institutions:

- the behaviour of local vector species regarding time of feeding and preference for indoor or outdoor, and human and animal feeding;
- the sleeping habits of the human population in relation to the feeding habits of the vector;
- ecological data on the breeding habits of local vector species; and
- baseline vector parameters, including parity rates, human-biting rates, human blood indexes, sporozoite rates and entomological inoculation rates (EIRs).

Collection methods designed to catch different species of *Anopheles* include human landing, indoor spray sheets, indoor and outdoor resting, exit traps, CDC light traps (with or without CO₂ augmentation), animal-baited traps, experimental huts and larval collections (3).

2.2.3 Geographical reconnaissance and mapping of structures and households

GR is defined as “the operation that provides the basis for the choice of field centres and depots, for detailed schedules and itineraries of spraying and surveillance personnel, for the final deployment of transport, and for the numerical control of the completeness of the work accomplished or reported” (4).

Before IRS begins, detailed information on the target areas should be collected. This should include the distribution, location, number, type, size and accessibility of households and structures to be sprayed. Maps showing roads, location of villages, water points and important geographical features such as lakes, streams and mountains should be prepared. The number, type and size of dwellings should be identified, mapped and recorded. Each household should be given a reference number to be painted on a door or a wall, and should be issued with a malaria house spray card so that spray operators can determine where and what they have to spray. This also enables spray team leaders to better supervise the work. The average surface area of unit structures or houses must be calculated to estimate the total number of square metres of surface to be sprayed and the amount of insecticide needed.

Detailed GR may not be financially or practically possible before the first spray rounds. However, a full GR should be conducted during the first round, and updated during subsequent rounds. The scope of GR will vary from country to country and programme to programme, depending on the available resources.

The tools and technology for GR and data management through geographical information systems (GIS) are evolving rapidly. Handheld electronic instruments such as smart phones, personal data assistants (PDAs) and tablets, as well as freely available basic satellite imagery of many targeted areas and powerful portable computing equipment all greatly increase the potential contribution GR can make. However, the fundamental principles, and the need for accurate and up-to-date basic information remain the same (5).

To help with the detailed recording of structures during GR, households can be rapidly geo-referenced, mapped and recorded in the field using integrated handheld PDAs fitted with a global positioning system (GPS). These data can then be added to base maps to provide detailed GR information of target IRS areas, thereby assisting in many aspects of operations.

Delineation of malaria risk areas to be sprayed

The areas to be sprayed should be identified during an initial assessment. They should then be delineated with clear identification numbers, and will form the basis of the GR within the boundaries. Topographical maps, available from government offices, which show administrative boundaries, roads, villages, water sources and other useful features will greatly facilitate the GR.

As national malaria control programmes progress, more and more areas within districts and countries should move from being high transmission to being low transmission, and finally become areas free of malaria. Clear boundaries need to be established between malaria-free zones and areas of low transmission, and between low-transmission zones and high-transmission zones. The methodology for the demarcation of malaria transmission zones requires the use of GIS relevant mapping resources.

Barrier IRS with a width of 1–2 km between malaria-free zones and low to high malaria transmission areas can be used to prevent re-invasion of areas where malaria has been eliminated (Fig. 1).

Mapping

Maps provide a spatial view, which significantly helps operational planning and guides spray teams to the structures to be sprayed each day.

FIG. 1
Map of Tanna showing 2 km buffer zone

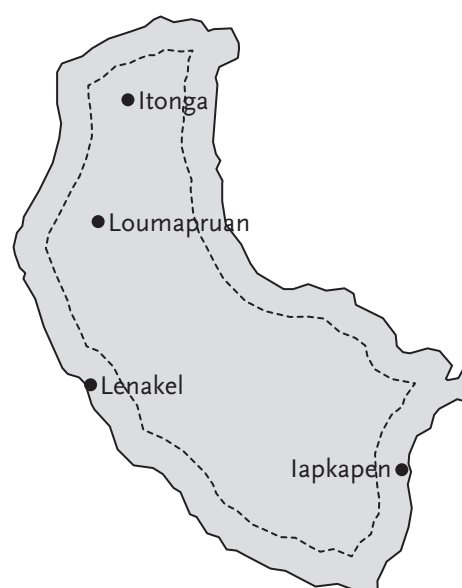

Adapted from map produced by National Vector Borne Diseases Control Program, Ministry of Health, Republic of Vanuatu, May 2009.

Detailed, printed topographical maps can often be obtained from the surveyor general's department or from local government planning departments. Field teams can develop hand-drawn sketch maps during the GR. Today, satellite imagery can be downloaded from free services such as Google Earth or Google Maps, with more detailed maps and images available from other online services.

With the aid of a compass, patterns of the structures or houses to be sprayed, together with their access routes, can be marked on a spot map and locations for field camps can be identified (Fig. 2).

Geographic information systems

Base maps obtained from various online resources are useful to support the planning of IRS operations by district and provincial malaria management teams. These maps can be updated with information on the location of households by entering household numbers, together with their details, on a handheld GPS, PDA or tablet.

Geographic databases contain country-specific information that is important for developing IRS operational plans, including:

- administrative boundaries (national, subnational)
- location of villages (including village names and codes)
- location and type of health infrastructure
- location and type of schools and other public infrastructures
- location and type of safe water points
- population by administrative level (to village level where available)
- roads, rivers, forests, elevation
- indicator data such as population subgroups (gender, sex, risk group), time, location and source.

In many countries, the geographic database has been developed in collaboration with ministries of health, integrating several datasets from a variety of sources in the country. This is a work in progress and in many countries the databases may still be incomplete.

Before undertaking GR, it is necessary to check what core geographic data may already be available in the country. GIS in a given country may already be well established in other government agencies and nongovernmental organizations (NGOs) working in health, agriculture, environment, public works, etc. The malaria control programme can collaborate with these institutions to prepare malaria risk maps (both spatial and temporal) using available malaria data. This type of database and mapping are excellent resources to support effective targeting of IRS.

The GR and house census can be carried out using either traditional paper questionnaires and topographical maps, PDAs or tablets. When used in the field by interviewers, PDAs can store and present information collected from survey questionnaires. They are advantageous due to the fact that they can be pre-programmed to navigate through questionnaire skip patterns and to adjust question wording for specific situations. With PDAs, survey results can be cleaned and downloaded quickly after fieldwork is carried out. Many PDAs also now come with GPS receivers (either embedded or as add-on devices) for automatically integrating geocodes with survey data.

FIG. 2
Spot map for IRS planning

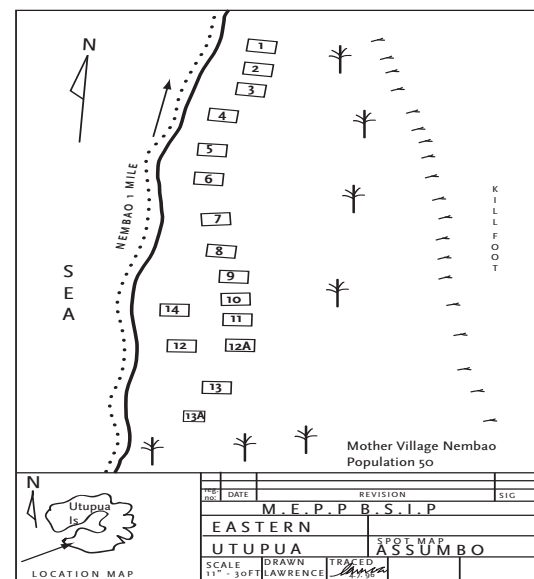

Map courtesy of Gerard Kelly, Technical Report. *An integrated approach to data collection, storage and mapping of household information for malaria assessment and elimination in the Solomon Islands.* August 2008.

In addition, PDAs with embedded GPS receivers can be useful for fully automating the process of survey sample design and mapping households for household listings. Household characteristics, such as previous spray history, the number of bedrooms sprayed and the number of unsprayed structures can be easily recorded.

An integrated approach to the collection, storage, analysis and mapping of relevant malaria data allows relatively easy, accurate and quick assessment, planning, monitoring, and reporting of a number of malaria control and elimination interventions (Fig. 3).

FIG. 3
Integrated approach to malaria information systems

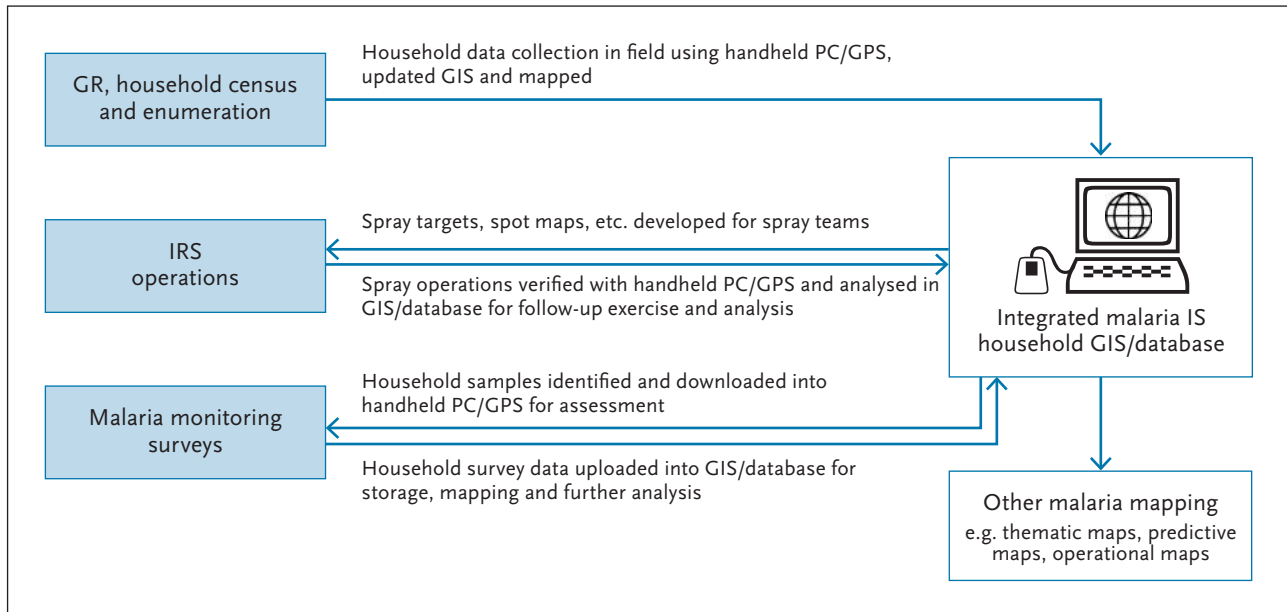

Figure courtesy of Gerard Kelly, Technical Report. *An integrated approach to data collection, storage and mapping of household information for malaria assessment and elimination in the Solomon Islands*. August 2008.

House geo-referencing for IRS using handheld PDAs or tablets and GPS

Geo-referencing and mapping of household structures using handheld PDAs or tablets and GPS can be used in the overall planning of IRS activities and to assist in monitoring spraying operations and follow-ups as shown in Fig. 4 below.

2.2.4 Population census

The starting point for the IRS population census is to look at the latest national population census document, inter-census surveys and demographic health surveys (DHS). These provide the basic information required, including:

- names of administrative areas (e.g. province, region, state, district, ward, parish, village) broken down to the lowest levels;
- names of major urban centres;
- population numbers by administrative areas and by rural and urban distribution;
- population structure by age groups (under or over 5 years, male or female);
- population distribution and density;
- average household size (number of people per household);
- number of rooms per household or dwelling;

FIG. 4
Mapping and IRS management cycle

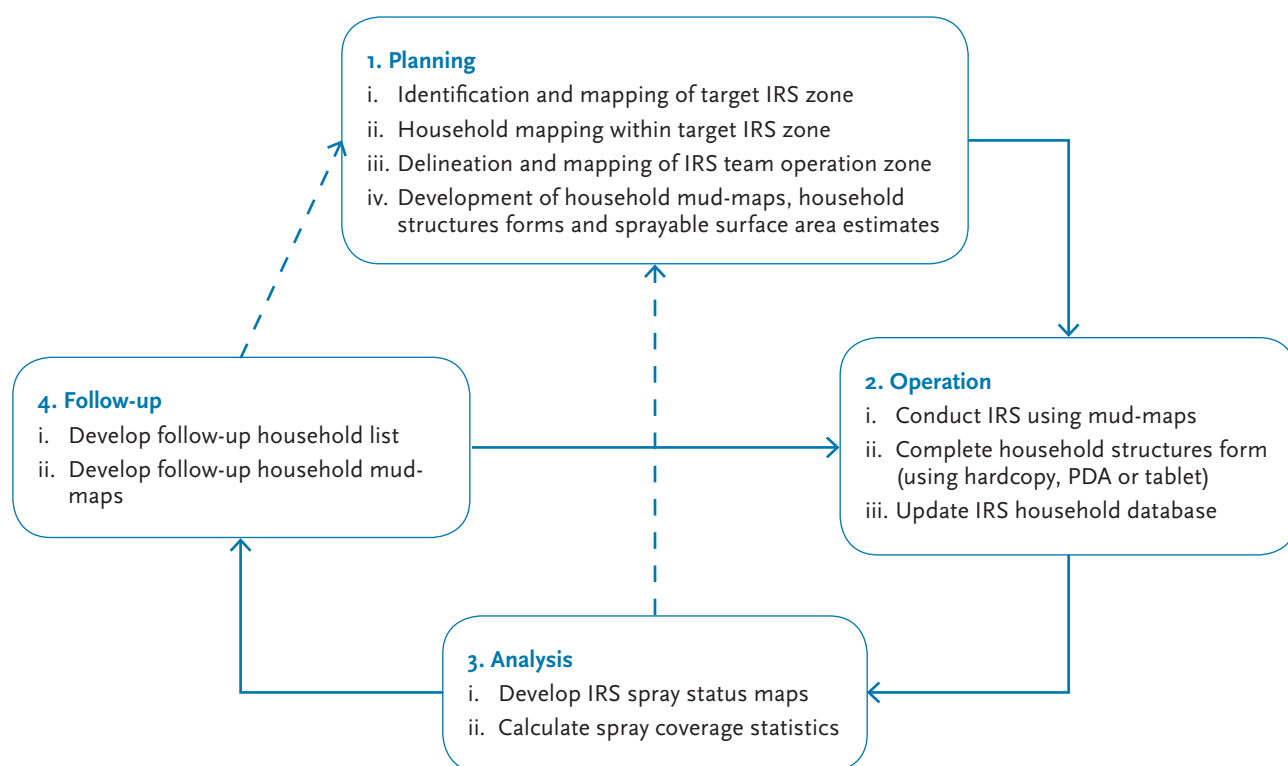

Source: WHO

- type of household and materials used for construction; and
- name of head of household.

The IRS teams should update the population data when they conduct house-to-house GR census prior to the spray campaign.

2.2.5 Estimating number, size and type of structures or houses

In order to plan an IRS campaign it is essential to know the:

- number of houses or structures;
- average number of rooms per household (e.g. sitting room, bedroom, kitchen, dining room, bathroom, toilet);
- average size of one room (in square metres of sprayable surface area);
- average number of persons per household; and
- type of materials used for construction of walls and ceilings (e.g. mud, thatch, brick, bamboo, corrugated iron).

IRS district coordinators should compile this information using the latest census data, local government records and health-sector data, as well as data from other major community-based programmes such as expanded programmes on immunization. They should establish an initial estimate of the number of structures or houses that require spraying, the number of spray rounds to be carried out in a year, and the details and location of areas that can be placed under active surveillance with target spraying in response to outbreaks. The determinants for targeting which areas should be sprayed are discussed in detail in Section 1.4. PDAs can also be used to record spray round information.

Estimating sprayable surface area

The average sprayable surface area of the target houses must be obtained before insecticide quantification and procurement. This is usually accomplished using a representative sample of 5–10% of the total houses. The surface and type of all the structures (main houses, animal shelters and other buildings) should be measured (inside walls, ceiling, doors and windows – inside and outside). The proportion of the different type of houses (traditional or modern) and average sprayable surfaces are estimated. From this information the quantity of insecticide needed can be estimated.

Most spray target areas contain two basic types of structures: traditional and modern (or formal). This classification is very useful in estimating the formulation of insecticide to be used in IRS operations and in determining the logistical requirements of the programme.

- A traditional or rural house/structure is constructed from materials readily available in the surrounding area (e.g. mud, thatch, sticks, rough lumber). These dwellings frequently have very few internal partitions and their internal walls are seldom finished with plaster or paint.
- A modern or urban house or structure is frequently constructed from finished lumber, cinder block or brick with multiple internal walls that have been plastered with a smooth finish or painted.

“Sprayable surface” is defined as the inside surfaces of all structures or houses that should be sprayed. This includes eaves not exposed to rain, ceilings, under-floor areas in raised housing, and the inside walls of latrines. Other structures in the village, outside the household compounds and where there are no sleeping areas, such as schools (except boarding school dormitories) and shops, should not be sprayed, as these will attract very few malaria vectors. Annex A1.1 shows an example of a sprayable surface record form for baseline estimation of insecticide quantification needs.

2.3 Selection of insecticides

Selection of insecticides for IRS is guided by the characteristics of the insecticides; the susceptibility status of the local vectors; the epidemiology of the disease, especially the duration of the transmission season; the environmental situation; and other factors relevant to the effectiveness of the IRS programme.

2.3.1 Type of action of insecticides

Different insecticides may have different effects on the particular species of mosquito through one or more of three types of action:

- repellent
- irritant
- killing.

In order to maximize the effect on vector survivorship and malaria transmission, insecticides with a high level of killing effect are preferred to those with a high level of repellent and irritant effect.

2.3.2 Characteristics of good residual insecticides

The following factors should be considered when selecting insecticides for IRS.

- *Efficacy*: for IRS to be effective, female anopheline mosquito vectors must be susceptible to the insecticide selected. Insecticides may lose their efficacy if the target insects develop resistance. Susceptibility studies should be conducted on samples of the target insect population collected

from the area. If resistance is observed, another insecticide, to which cross-resistance is unlikely, must be selected (6).

- **Residual effect:** the most important quality of a residual insecticide is its long-acting effect on a given surface and high toxicity to vector mosquitoes. The toxicity should remain effective for a period long enough to cover the malaria transmission season.
- **Correct formulation:** optimum effectiveness of IRS can be achieved by spraying the right formulation on the right type of surface. For instance, wettable powders (WP) and water-dispersible granules (WG) are best suited to very porous surfaces such as mud walls, while suspension concentrates (SC) or emulsifiable concentrates (EC) are more effective on finished cement, finished wood or timber, or painted surfaces, especially those where oil-based paints have been applied. It should be noted that on smooth non-absorbent surfaces (such as painted brick walls) it is essential to apply less volume of insecticide (i.e. 30 ml/m² instead of 40 ml/m²).
- **Robustness (stability):** the insecticide selected should be stable during transportation and storage, at room temperature, and with minimum ventilation. It should mix evenly or dissolve in the selected solvent and it should be harmless to the spray equipment.
- **Safety:** insecticides are inherently hazardous. However, when handled and applied according to label recommendations, WHOPEs-recommended insecticides carry a low risk and will provide the desired results. When properly applied the insecticides used for IRS should pose no danger to spray workers, householders, domestic and wild animals or the environment. Steps to mitigate accidental contamination and spills should be implemented prior to commencing spray operations.
- **Acceptability:** some insecticide groups and formulations have been found less acceptable by householders due to their peculiar smell or because they leave unsightly deposits on the sprayed surfaces. Acceptability may vary by location.
- **Cost:** programmes should monitor costs according to standard cost categories (i.e. operations, labour, equipment, personal protective equipment, insecticide, and administration). Costs can then be calculated per unit structure sprayed or per population protected.

2.3.3 Classes and compounds of insecticides

Insecticides used in public health are usually contact insecticides and considered either residual or non-residual. Residual contact insecticides are stable, organic chemicals which, when applied, remain toxic for a given period (usually several months) to insects alighting on or walking over that surface. By contrast, a non-residual insecticide may be used for space spraying where it is quickly degraded and does not persist in the environment.

Classification

Insecticides recommended by WHO for IRS fall into four major classes:

- **carbamates (C):** bendiocarb, propoxur
- **organochlorines (OC):** DDT
- **organophosphates (OP):** malathion, fenitrothion, pirimiphos-methyl
- **pyrethroids (PY):** alphacypermethrin, deltamethrin, lambda-cyhalothrin, etofenprox, bifenthrin, cyfluthrin

These insecticides are chosen based on safety for humans and their residual efficacy when applied to a dwelling surface. The minimum residual period required of the currently available residual insecticides is 2–6 months. They are available in various formulations to increase their longevity on different surfaces.

Compounds

Under the major classes of chemicals there are different compounds sold by different manufacturers using different trade names. These trade names should not be confused with the type of active ingredient (a.i.). For instance, the a.i. of Fendona® is alphacypermethrin and the a.i. of K-Othrine® is deltamethrin. The use of trade names is to be avoided since a product may be registered under different trade names in different countries, and therefore be unfamiliar to programme managers.

The most important criterion to be considered is the a.i.; it is essential to check if the compound meets WHO specifications and if the manufacturer has submitted the product for evaluation with WHOPES. A complete list of WHOPES-recommended insecticides is provided in Section 2.3.4 and can be found online at <http://www.who.int/whopes/en/>

Concentration

The concentration of the products is displayed as a.i./kilogram or a.i./litre.

Formulation for type of sprayable surface

IRS insecticides are applied as formulations adapted to the type of surface to be sprayed. A formulation is a mixture of one a.i. with an inert ingredient that has no pesticide action. All residual insecticides are toxic to most insects in very small doses; thus, for their efficient application, some dispersion medium is necessary.

Residual insecticides for spray application are generally formulated as:

- wettable or water-dispersible powder (WP)
- emulsifiable concentrate (EC)
- suspension concentrate (SC)
- water-dispersible granule (WG)
- capsule suspension (CS).

The major characteristics of the different formulations and their impact on IRS are described in Table 3 below.

WP formulations are the most commonly used insecticides for IRS in rural areas on porous surfaces (e.g. mud and thatch walls) in traditional buildings. EC formulations and SC formulations are used on modern buildings for spraying impervious and painted surfaces because they do not cause spots and stains.

WP, WG and CS formulations have longer residual effect, except on non-absorbent surfaces where the effectiveness and persistence of all three kinds of formulations are the same. Recently introduced CSs are showing longer residual activity especially on porous surfaces.

Types of sprayable surfaces

The persistence of an insecticide sprayed on a surface varies with the type of insecticide, its formulation and the type of surface. Most insecticides last longer on wood and thatch than on mud. Mud surfaces, cement blocks, concrete and brick absorb the insecticide, and certain types of mud may also break it down chemically. The residual efficacy of insecticides on absorbent surfaces is 10–20% less than on non-absorbent surfaces. Therefore, it is important to ensure the right concentration of the recommended dosage is sprayed on non-absorbent surfaces.

Application rates

The application rate is the amount of a.i., expressed in grams per square metre (g/m²) of the insecticide applied to a unit of surface area. The correct application is one of the most important issues in IRS programmes. Monitoring systems must be established to ensure that the correct

TABLE 3
Different insecticide formulations

FORMULATION	DESCRIPTION	ADVANTAGES	DISADVANTAGES
Wettable powder (WP) and water-dispersible granule (WG)	The a.i. is added to an inert powder containing a wetting and dispersing agent; Forms a suspension in water	Effective on porous surfaces (mud bricks/ concrete walls); Easy to transport, store and use; Relatively inexpensive	Ineffective on plastic sheeting, canvas tents, oil-based paint; Spray tank needs occasional agitation/shaking; Risk of exposure to dusts and spills during mixture
Emulsifiable concentrate (EC)	The a.i. is dissolved in an oil-based solvent and emulsifiers. When mixed with water it forms a milky, white oil-in-water emulsion composed of finely suspended droplets carrying the insecticide	Easy to mix with water; Few visible deposits; More effective on cement, wood or lumber; Effective on oil-based painted surfaces; High concentration of a.i. in each container	Strong smell; Absorbed by porous surface; High dermal absorption increases risk for operators; Flammable
Suspension concentrate (SC)	Contains tiny particles of a.i. suspended in a liquid (usually water); Forms crystalline particles, but smaller than those formed with WP and WG.	Safer for operators; Less visible residues than WP; Effective on cement, wood or lumber and on oil-based paints.	Less effective on plastic sheeting
Capsule suspension (CS)	The a.i. is encapsulated in microscopic polymer capsules. Suspended in water for spraying.	Capsules release the insecticide slowly after spraying, extending compound's residual life.	Constant agitation is needed to ensure the polymer capsules remain in suspension.

application rates are adhered to at all times. Training programmes for spray operators should always focus on proper application techniques.

Number of spray rounds

The implementation of spray operations of all sprayable houses in an area over a period of time is called a spray round. The repetition of spray rounds at regular intervals is the “spraying cycle”. The frequency of the spraying cycle will depend on the malaria transmission patterns of the area and the residual effect of the insecticide formulation chosen. Spray rounds should ideally be completed in less than 2 months and just before the transmission season. In endemic areas with perennial transmission, two rounds of spraying in 6-month cycles may be recommended to ensure that there is adequate year-round coverage with residual insecticides. If the transmission pattern exhibits bimodal peaks, spraying rounds should target the peaks. In areas with one seasonal transmission, one spray round, in yearly cycles before the period of transmission, should be enough to have an impact on malaria transmission.

2.3.4 WHO-recommended insecticides for IRS

Public health insecticides are under continuous review by WHOPES, with 15 currently recommended for use in IRS. These have been used safely and effectively in many countries around the world to control malaria vectors. Table 4 presents a list of WHOPES-recommended insecticides for IRS as of November 2014. Updates to this are available at <http://www.who.int/whopes/quality/en>

TABLE 4
WHO-recommended insecticides for IRS against malaria vectors

INSECTICIDE COMPOUNDS & FORMULATIONS ¹	CLASS GROUP ²	DOSAGE (g a.i./m ²)	MODE OF ACTION	DURATION OF EFFECTIVE ACTION (MONTHS)
DDT WP	OC	1–2	Contact	>6
Malathion WP	OP	2	Contact	2–3
Fenitrothion WP	OP	2	Contact & airborne	3–6
Pirimiphos-methyl WP, EC	OP	1–2	Contact & airborne	2–3
Pirimiphos-methyl CS	OP	1	Contact & airborne	4–6
Bendiocarb WP, WP-SB	C	0.1–0.4	Contact & airborne	2–6
Propoxur WP	C	1–2	Contact & airborne	3–6
Alpha-cypermethrin WP, SC	PY	0.02–0.03	Contact	4–6
Alpha-cypermethrin WG-SB	PY	0.02–0.03	Contact	< 4
Bifenthrin WP	PY	0.025–0.050	Contact	3–6
Cyfluthrin WP	PY	0.02–0.05	Contact	3–6
Deltamethrin WP, WG, WG-SB	PY	0.020–0.025	Contact	3–6
Deltamethrin SC-PE	PY	0.020–0.025	Contact	6
Etofenprox WP, WG	PY	0.1–0.3	Contact	3–6
Lambda-cyhalothrin WP, CS	PY	0.02–0.03	Contact	3–6

¹ CS, capsule suspension; EC, emulsifiable concentrate; SC, suspension concentrate; SC-PE, polymer-enhanced suspension concentrate; WG, water-dispersible granule; WG-SB, water-dispersible granules packaged in water-soluble bags; WP, wettable powder; WP-SB = wettable powder in sealed water soluble bags

² OC, organochlorines; OP, organophosphates; C, Carbamates; PY, pyrethroids.

Note: WHO recommendations on the use of pesticides in public health are valid ONLY if linked to WHO specifications for their quality control. WHO specifications for public pesticides are available on the WHO website at <http://www.who.int/whopes/quality/en/>.

Use of DDT in IRS

The use of DDT is strictly governed by the protocols of the Stockholm Convention on Persistent Organic Pollutants of 2001 and the specific recommendations by the WHO that allow DDT production and use strictly for public health purposes related to disease vector control. As stated in the WHO Position Statement on the use of DDT in Malaria Vector Control:

Concerns about the safety of DDT

DDT has a low acute toxicity on skin contact, but if swallowed it is more toxic and must be kept out of the reach of children. Because of the chemical stability of DDT, it accumulates in the environment through food chains and in tissues of exposed organisms, including people living in treated houses. This has given rise to concern in relation to possible long-term toxicity. The risks that DDT poses to human health are re-evaluated by WHO whenever there is significant new scientific information. In 2000, the Joint FAO/WHO Meeting on Pesticide Residues undertook a comprehensive re-evaluation of DDT and its primary metabolites including storage of DDT and its metabolites in human body fat; the presence of residues in human milk and the potential carcinogenicity; and biochemical and toxicological information including hormone-modulating effects. While a wide range of effects were reported in laboratory animals, epidemiological data did not support these findings in humans.

New information published since 2000 was evaluated by a WHO Expert Consultation held in December 2010 (7). This information included new epidemiological studies, up-to-date reported levels in human milk, and new information on exposures to DDT occurring as a result of IRS. A detailed exposure assessment was undertaken, including potential exposure to both residents in IRS-treated homes as well as to spray operators. The WHO Expert Consultation concluded that in general, levels of exposure reported in studies were below levels of concern for human health. In order to ensure that all exposures are below levels of concern, best and safe application practices

must be strictly followed to protect residents, workers, and avoid environmental contamination. Based on the most recent information, WHO has no reason to change its current recommendations on the safety of DDT for disease vector control. However, WHO's position on the safety and use of DDT will be revised if new information on the potential hazards of DDT becomes available justifying such a revision (8).

When considering the use of DDT, programmes should take into account the additional reporting requirements to the Stockholm Convention, additional environmental assessment procedures that may be required (e.g. the need in some programmes for a public comment period), and additional procedures for disposing of empty containers and other contaminated waste. DDT has the longest residual effect (6–12 months) compared to other classes of insecticide and thus may reduce the number of applications required in perennial transmission areas. In terms of insecticide resistance, there is cross-resistance with pyrethroids in some situations, but in other situations the vector may be resistant to pyrethroids and to carbamates, but still susceptible to DDT. As with all insecticides, there needs to be careful monitoring of insecticide susceptibility and a robust plan for insecticide-resistance management as outlined in the GPIRM (6). In addition, there needs to be good stock management through stringent accounting, secure storage and close supervision to prevent illicit diversion and use, especially for agriculture.

2.3.5 Estimating insecticide requirements

To estimate the amount of insecticide required for an IRS spray round, the following is needed:

N: number of houses to be sprayed (expressed as the percentage of modern and traditional structures);

S: average sprayable surface per house in m² (modern and traditional structures);

C: concentration of the active ingredient in the formulation (% a.i.); and

Y: target dosage expressed in g/m² (application rate) of insecticide to be used on each type of structure according to WHO recommendation (Table 4).

Once this information is gathered, **Q**, the total quantity of insecticide needed (kg) is calculated as shown below:

$$Q = \frac{S \times Y \times 100}{C} \times N = \text{XXX,XXX g}$$

Note: When the full quantity of insecticide needed is calculated it should then be increased by 10% to overcome any possible shortage.

Example 1a: Determine the amount of insecticide formulation required to treat 11 607 formal structures with an average sprayable surface area of 300 m². The insecticide formulation selected is lambda-cyhalothrin 10% WP. The dose to be applied (application rate) is 0.025 g of a.i. per m².

$$Q = \frac{300 \times 0.025 \times 100}{10} \times 11\,607 = 870\,525 \text{ g}$$

870.5 kg of insecticide formulation are required to spray 11 607 structures/houses; + 10% buffer stock = 87 kg

The total amount of lambda-cyhalothrin required: 957.5 kg

Example 1b: Determine the amount of insecticide formulation required to treat 6250 traditional structures with an average sprayable surface area of 125 m². The insecticide formulation selected is DDT 75% WP. The dose to be applied (application rate) is 2.0 g of a.i. per m².

$$Q = \frac{125 \times 2.0 \times 100}{75} \times N = \frac{125 \times 2.0 \times 100}{75} \times 6250 = 2\ 083\ 333\ \text{g}$$

2083.3 kg of insecticide formulation are required to spray 6250 structures/houses; + 10% buffer stock = 208 kg

Total amount of DDT required: 2291.3 kg

2.3.6 Management of insecticides

Insecticide (pesticide) management is the regulatory control, proper handling, supply, transport, storage, application and disposal of insecticide products to minimize adverse environmental effects and human exposure. Additional guidelines and best practices are available through WHO and Food and Agriculture Organization of the United Nations (FAO) as well as from manufacturers of the particular insecticide.

National insecticide registration

WHOPES-recommended insecticides are based on tests and assessments on their efficacy and safety. However, national regulatory authorities, ministries of public health and environmental authorities may require additional assessments and procedures. Guidelines and additional information on national pesticide registration are available from WHO (9).

The national registration process is usually as follows.

- The agent or company wishing to register a compound completes specified forms supplied by the national authority for the registration of agricultural pesticides or public health insecticides for use in IRS for malaria control.
- Information must be provided regarding the a.i., proposed use, formulation characteristics, toxicity and handling issues.
- The application must be accompanied by documentation of all trials for efficacy and safety, including where and how they were conducted.
- The documents are reviewed by the registration authority and submitted to the ministry of health and the national environmental agency for review and comment.
- If there are no problems and the documentation is complete, a registration number is assigned.
- Compounds using the same a.i. as previously registered compounds may be registered more quickly.
- Depending on national capacity in entomological research, field trials may be requested in the local country context. However, the assessment may rely primarily upon reviews and trials carried out in other countries and on the recommendations of WHOPES.
- All insecticides must have labels in local languages and sample labels are required before registration.

WHOPES provides detailed guidance for sound management of public health pesticides throughout their life-cycle, including issues related to the registration, distribution and sale, use and application, and disposal of pesticide waste, as well as to training and awareness raising and to enforcement of pesticide regulations (10).

National environmental assessment for insecticide application

Before procuring or using insecticides for malaria control, many countries and programmes require an environmental assessment. This may include the:

- health and environmental registration status of the insecticides;
- rationale for selection and conditions of use for the insecticide(s);
- availability and effectiveness of other alternative pesticides or nonchemical control methods;
- extent to which the proposed insecticide use is part of an integrated disease control programme;
- availability of the appropriate application and safety equipment;
- acute or long-term toxicological hazards (if any), either human or environmental, associated with the proposed use, and measures available to minimize such hazards;
- provisions made for training coordinators, supervisors and spray operators on safe handling and use of insecticides;
- provisions made for monitoring the safe handling, use and effectiveness of the insecticides; and
- public health and environmental regulatory institutions' ability to regulate and control the distribution, storage, use and disposal of the pesticide.

Environmental risk

Environmental risks include contamination that could adversely affect humans, domestic animals and aquatic organisms. This risk can be mitigated through ensuring:

- secure and safe storage of insecticide with adequate inventory and stock control procedures;
- intensive supervision of spray teams and spray operators to ensure proper insecticide handling and use;
- audits of used insecticide sachets and containers;
- the use of standard sprayers and effective maintenance;
- recycling of wastewater used for washing equipment; and
- the appropriate incineration of empty sachets.

Packaging and storing insecticides

Packaging

Insecticides should be carefully handled. It is important that spray charges (or the quantity of the insecticide needed in one sprayer of 7.5 or 10 litre spray capacity) are pre-packed to facilitate easier transportation, handling and efficient filling of the sprayers. The programme should use the WHO (10) and Roll Back Malaria (RBM) (11) guidelines for procurement of public health insecticides. Measured amounts of insecticides should be pre-packaged in sachets or plastic bottles corresponding to the operational capacity of the sprayer (i.e. 7.5 or 10 litres of water). For wettable powders, water soluble sachets that can be placed directly in the spray tank are preferred. A sprayer fitted with a 1.5 bar control flow valve (CFV) and using an 8002E nozzle would require 7.5 litres of water to be mixed with the insecticide.

Packaging should be sufficiently robust to withstand any difficult transportation, handling, storage and climate conditions to which the insecticides may be exposed.

Insecticide containers should be clearly labelled. They should also be rigid, leak-proof, weather-, tamper- and rat-resistant. If containers are damaged, the insecticide should be re-packaged with clear labelling. Plastic bags and bottles, shipping boxes and other insecticide containers should be disposed of safely after use by means of appropriate incinerators.

Storage

Insecticides must be kept in a safe storeroom with a current inventory and stock control number and audit system. The storeroom should be free from moisture and heat (out of direct sunlight) and well ventilated. The containers should be placed above ground level and not directly on the floor. Insecticides must be kept in the original packaging and containers and only transferred into sprayers as needed. Insecticides should be kept away from food, animal feed, children and unauthorized persons. Detailed organization and management of stock can be found in the FAO *Pesticide storage and stock control manual* (12).

Insecticide safety procedures

Insecticides, like drugs, have inherent potential hazards. However, if they are handled and applied according to label specifications, they will be safe and effective. Safety instructions must be followed at all times to avoid potential problems for operators, household residents, pets and domestic animals and the environment. Safety procedures and best handling practices are described Chapter 3, but include reducing risk to household residents by ensuring they:

- remove as much of their household contents as possible, specifically water, food, cooking utensils and toys;
- move furniture away from the walls to allow easy access for spraying of walls and cover furniture with a plastic tarpaulin or sheeting. All pictures, wall hangings and posters should be removed. Items that cannot be removed should be well covered with a plastic sheet and placed in the centre of the room; and
- relocate, cage or leash pets and domestic animals away from the house until sprayed surfaces have dried and the dead insects have been swept up and removed from the floor. They should be kept outside for at least an hour after spraying is complete. This will avoid the temporary skin and eye irritations that may occur with some of the chemicals.

Chronic exposure risk for spray operators is minimized by the wearing and regular washing and changing of protective clothing when handling insecticides and during all spray operations. Spray operators may also require periodic medical examinations, depending on the insecticide they are applying. Some countries, for example, may require weekly monitoring of acetylcholinesterase (AChE) among spray personnel using organophosphates such as fenitrothion.

The WHO Expert Committee on Vector Biology and Control has considered worker safety when applying carbamates and organophosphates and gives the following information (13):

- carbamates – no testing required;
- pirimiphos-methyl and malathion – safe enough to be applied operationally without requiring routine cholinesterase monitoring, provided protective clothing is regularly cleaned and a high standard of personal hygiene is maintained;
- fenitrothion – at the limit of acceptable toxicity for conventional indoor application. Its relatively narrow safety margin calls for strict precautionary measures and regular cholinesterase monitoring of exposed people throughout the spraying operation; and
- propoxur – no cholinesterase monitoring required (it is a carbamate) but conclusions on use are similar to those with fenitrothion (i.e. it is at the limit of acceptable toxicity with narrow safety margins, and strict precautionary measures must be followed).

Safety precautions

Exposure to insecticides may occur during the following stages of the spraying process:

- opening of the package
- mixing of insecticide
- loading of the sprayer
- maintaining the equipment
- spraying, especially in high, overhead places
- through spillage
- during disposal.

The following safety precautions should be taken:

- read the label carefully and understand the directions for preparing and applying the insecticides, as well as the precautions listed;
- follow the directions and precautions exactly;
- know the first-aid measures and antidotes for the insecticides being used;
- use protective clothing while handling and spraying insecticides;
- mix insecticides in a well-ventilated area, preferably outdoors;
- rinse container for liquid insecticides properly (see below);
- make sure that the spray equipment does not leak and check all joints regularly;
- avoid skin contact;
- use dedicated equipment for measuring, mixing and transferring pesticides;
- use pre-packaged insecticides with the appropriate quantity of water in the sprayer;
- ensure the sprayer is depressurized before opening the lid;
- do not eat, drink, smoke or use mobile phones while handling and spraying insecticides;
- wash hands and face with soap and water after spraying and before eating, smoking or drinking;
- shower or bathe at the end of every work-day and change into clean clothes;
- wash overalls and other protective clothing at the end of each work day in soap and water and keep them apart from the rest of the family's clothes;
- change clothes immediately if they become contaminated with insecticides;
- keep two sets of protective clothing in different colouring to avoid using the same uniform as the previous day. In this way, it is always possible to use one set while the other is being washed;
- do not clear blocked spray nozzles by blowing with the mouth; and
- inform the supervisor immediately if feeling unwell.

Triple rinse method for containers of liquid insecticide small enough to shake

- Empty the remaining contents into the application equipment /mix tank and drain for at least 30 seconds after the flow begins to drip
- Fill the container ¼ full with clean water and securely re-close the cap
- Shake, rotate and invert the container so that the water reaches all the inside surfaces
- Either add the rinsate to the application equipment or the mix tank, or store it for later use or disposal
- Allow the container to drain for 30 seconds after the flow begins to drip
- Repeat the procedure at least twice more until the container appears clean.

Further information can be obtained from US Environmental Protection Agency (14).

Empty sachet disposal

All empty sachets and containers should be collected by the team supervisors and taken to the central storage area for proper disposal by qualified staff. Burning in a conventional open fire will not destroy any residual insecticides and may generate environmentally toxic emissions (15).

Good inventory control is essential to ensure that each empty sachet or container has been collected and not diverted for unauthorized use.

Disposal of expired stock of insecticides

Insecticides should not be allowed to expire. This can be avoided through proper planning and accurate estimation of needs. Should expiry occur, the means of safe disposal should be decided by the national authorities (ministry of health, ministry of agriculture, ministry of the environment) according to the available disposal facilities in the country and in compliance with international conventions related to international transportation of pesticides.

Expired insecticides can sometimes be extended beyond their expiry date in consultation with the manufacturer and quality control centres. If this is not possible, large quantities of insecticides are best disposed of by incineration in specially designed incinerators that are able to reach a temperature of 1200 °C. If such equipment is not available in-country, expired insecticides should be returned to the supplier or passed on to a specialist disposal agent selected by the national authorities.

2.3.7 Insecticide procurement and quality control

Insecticides should only be procured if they conform to WHOPES specifications as previously outlined, and if they are registered in the country of use. WHO has recently published guidelines for procurement of public health pesticides (10).

Quality control for all insecticide procurement is important in terms of the concentration of a.i.; the level of impurities; and, especially in the case of wettable powders, the quality of the suspension when mixed in a sprayer, which may vary from one procurement to the next.

Insecticides packaged in a water-soluble sachet significantly decreases human and environmental exposure to the insecticide and should be encouraged in procurements.

One of the conditions for the supply of pesticides should be that all products offered must conform to WHOPES specifications. Conforming to these specifications will ensure high-quality insecticides are provided to programmes and help exclude suppliers who cannot guarantee the quality and performance of their products. Unwillingness to guarantee conformity and compliance to these specifications should result in rejection of a supplier.

Procurement tender specifications and labelling

Tender documents should be prepared on the basis of legal provisions on the procurement of goods and services in the country, including those specific to pesticides. The format of the tender document will vary from country to country but usually consists of three sections:

- *Section 1* provides information on the procurement procedure, including instructions to tenderers, conditions of tenders and technical specifications and requirements of the products being procured.
- *Section 2* contains the schedule of requirements, such as time, quantity and place of delivery.
- *Section 3* describes the contract for procurement. Instructions to tenderers inform them about the procurement process and the actions they must take to comply with the requirements. The instructions are based on the legal requirements for procurement of goods and include the scope of the tender; procedures for tender submission, opening and evaluation; and award of a contract. The principles of sound public procurement must be followed by providing

potential suppliers with accurate technical information and specifications for the products to be procured.

Open tenders are often advertised in newspapers, international journals or the Internet, to promote competition and allow procurement entities to obtain pesticides at the best possible price.

The tender documents include the technical specifications and other requirements that define the commercial and logistic framework for procurement. They include:

- pesticide specifications (without specifying trade names);
- technical specifications and documentation to be submitted in support of compliance requirements for outer packaging and shipping. This includes compliance with norms, dimensions, volumes, stacking requirements, materials, crush resistance padding and external marking;
- quantities and delivery schedules, required delivery terms (e.g.: 'free carrier', nearest terminal sea-port or airport) and ordering procedures;
- applicable terms and conditions that will form the basis for selection;
- the deadline for submission of bids, which should not be so short as to restrict competition;
- timetables for orders and delivery (bidders should be alerted to any anticipated delays, e.g. if the pesticides have still not been authorized for use in the destination country);
- procedures for awarding tenders;
- any special conditions in adjudicating tenders, such as preference for products recommended by WHOPES;
- request for a statement of the supplier's administrative and legal status and its link with the product; and
- a standardized proposal form, stating delivery times, expected delivery date, gross weight of the order, personnel involved with contact details, and a quotation for the total amount, including any discounts.

Other information in the document should include the name and address of the procurement entity and the place of delivery of the goods. Some countries also require tender specifications to include registration or authorization for importation of the pesticide or LLINs in the country of use.

Tender documents can also contain other administrative requirements, such as insurance requirements, percentage of advance payment, payment schedule, interest for payment delays, and bond for satisfactory completion of contract.

Labelling

Labelling must conform to the requirements of national registration authorities regarding insecticide labelling for public health use.

Quality control: checking product on delivery

Preferably before shipment, but failing this, upon delivery, random samples for quality control should be taken by the national drugs and insecticides regulatory authority from the different batches of consignment. These samples should be sent to independent analytical laboratories to ensure that the product conforms to the required specifications. Such testing should be paid for by the supplier. The testing should not be limited to the amount of a.i., but to all physical and chemical properties of the product as detailed in the specifications.

WHO provides guidance to national health authorities and offers assistance through designated WHO collaborating centres on quality control of insecticides. WHO procedures for quality control for public health pesticides are available at <http://www.who.int/whopes/quality/en/>.

2.3.8 Insecticide use: annual reporting

WHO encourages all countries using insecticides for IRS to submit annual reports on the class, compound, formulation and concentration used (see Annex A1.3 for an example of annual reporting on insecticides used). This allows WHO to monitor and plan support for countries in terms of insecticide specifications and use. It also enables both individual countries and WHO to advise industry of changes in the size and needs of the market, and of the priorities for research and development.

WHO-UNEP guidance on DDT use and reporting

All countries that are signatories to the Stockholm Convention on Persistent Organic Pollutants and that either produce or use DDT for IRS for the control of malaria or other vector-borne diseases are required to report on its use every 3 years.

There is a standard format for such reporting by each country as described in paragraph 4 of Part II of Annex B of the Stockholm Convention on Persistent Organic Pollutants (Section A) combined with a questionnaire for reporting other information relevant for the evaluation of the continued need for DDT for disease vector control (Sections B, C and D). The Stockholm Convention text is available at

<http://chm.pops.int/Convention/ConventionText/tabid/2232/Default.aspx>.

<http://chm.pops.int/Implementation/Exemptions/AcceptablePurposesDDT/tabid/456/Default.aspx>

WHO supports national malaria control programmes on the effective and safe use of public health insecticides including DDT for IRS in malaria control as outlined in the position statement on the use of DDT (8). The United Nations Environment Programme (UNEP) and WHO give support to national environmental agencies to monitor the regulation and use of DDT and other public health insecticides for IRS in malaria control.

2.3.9 Managing insecticide resistance

Insecticide-resistance monitoring

Insecticide resistance is when the *anopheline* vectors are no longer killed by the standard dose of insecticides used for IRS or when they manage to avoid coming into contact with the insecticide sprayed on inside house walls.

Before finalizing the choice of an insecticide for IRS, it is essential to test the susceptibility of the target vector populations to a range of insecticides. This should include the insecticide whose use is being considered as well as possible alternatives. WHO-recommended standardized test systems should be used (16).

An initial baseline survey should be followed by longitudinal monitoring at sites in different eco-epidemiological areas. Maximum effort is required to ensure the testing is standardized and supervised to ensure comparability of data from different sites.

Sentinel sites for monitoring insecticide susceptibility should include both areas that are sprayed as well as comparable areas that are not. As detailed in the testing guidance literature, the WHO tube assay and the CDC bottle assay should be the primary methods by which resistance to insecticides is initially detected and identified. Molecular and biochemical assays have an important role in providing additional information on mechanisms, but should not be a substitute for these standardized bioassay methods.

The two main type of insecticide-resistance mechanisms are:

- metabolic resistance, which is mediated by a change in the enzyme systems that normally detoxify foreign materials (including insecticides) in the insect. Resistance can occur when increased levels or modified activities of an enzyme system cause it to detoxify the insecticide

much more rapidly than usual, thus preventing the insecticide from reaching its intended site of action; and

- target-site resistance, which occurs when the molecule that the insecticide normally attacks (typically within the nervous system) is modified, such that the insecticide no longer binds effectively to it, and the resistant insect is therefore unaffected, or less affected, by the insecticide.

Cross-resistance can restrict the choice of alternative insecticides. Cross-resistance often occurs between insecticide classes that have the same mode of action for killing vectors. For example, if a resistance gene creates a change in a target site in a vector, it is likely to affect any other insecticides that attack that same target site, thus conferring cross-resistance. Similarly, an alteration to an enzyme that affects susceptibility to one insecticide may result in cross-resistance to another.

Resistance genes can spread rapidly in malaria vector populations over large areas. Data also suggest that resistance can evolve swiftly, occurring at low frequency for many years without being detected and then increasing rapidly to very high levels, to a stage at which it becomes less likely or even impossible to reverse the trend.

Once IRS operations have started, it is important to regularly monitor the susceptibility of the target vector populations by conducting at least one survey every year with a sufficient number of representative sentinel sites in the areas targeted for IRS. As outlined in the GPIRM, programmes should ideally plan rotation schemes, even pre-emptively, before resistance is detected. Programmes should complete any required national pesticide registration, carry out environmental impact assessments, and implement pesticide management plans for potential alternate insecticides, so that when the time comes, the rotation can be made quickly and efficiently.

Resistance management

The strategy for resistance management is based on current WHO guidance found in the GPIRM. This guidance may be adapted and revised as more evidence and research results become available. Updates of these recommendations are available on the WHO GMP website at <http://www.who.int/malaria/en/>.

Specific resistance management strategies for each geographic area should be based on current national programme vector-control interventions, the status of resistance and the epidemiological context. For IRS, the recommendations focus on pre-emptive use of rotations of different classes of insecticides. For LLINs, the options are currently limited to pyrethroids, and strategies will require consideration on a case-by-case basis. Four different classes of insecticide formulations are available for IRS, representing two modes of action. As described in the GPIRM, the response should focus on areas where resistance is of greatest concern. Whenever possible, countries should introduce focal IRS with non-pyrethroids in addition to LLINs in resistance “hot spots”.

If resistance is detected, even before any control failure that could be potentially linked to this is observed, the best solution is to shift rapidly to a suitable alternative insecticide. The choice of alternative should take into account information concerning the resistance mechanism identified. Insecticide choice may need to be extremely area specific, even down to district level. A change of insecticide will have potential logistical and financial implications and should only be made after careful review.

Strategies for delaying/avoiding the onset of resistance

As detailed in the GPIRM, a resistance management strategy includes preservation of insecticides susceptibility; slowing down the evolution of resistance; and prolonging the effectiveness of current vector-control interventions. The best way to delay resistance is to spray insecticides

only when and where they are really needed. It is important to determine the origin of selection pressure: whether it is due to public health use alone or also related to use in agriculture, domestic pest control, or a combination of all three. If resistance pressure appears to be resulting from agriculture or from domestic pest control (including private pest control operators) steps need to be taken to coordinate with the ministry of agriculture and national regulatory authorities.

There are several options for preventing or slowing down the evolution of resistance. The following broad principles should be kept in mind when addressing resistance issues:

- avoid indiscriminate use of insecticides by planning targeted interventions with care and deliberation;
- avoid use of the same insecticide against both adults and larvae;
- avoid use of same class or related insecticides for IRS and LLINs in the same area;
- avoid excessive or unnecessary IRS operations; and
- change the insecticide(s) being used before resistance reaches a high level.

Tactics for managing resistance include the following.

- *Rotations of insecticides*: Two, or preferably more, insecticides with different modes of action are rotated from one year to the next.
- *Combination of interventions*: Two or more insecticide-based vector-control interventions are used in a house (e.g. pyrethroids on nets and an insecticide of a different class on the walls), so that the same insect is likely, but not guaranteed, to come into contact with the second insecticide if it survives exposure to the first.
- *Mosaic spraying*: One compound is used in one geographic area and a different compound in neighbouring areas, the two being in different insecticide classes; further research is required on the use of mosaics.
- *Mixtures*: Two or more compounds of different insecticide classes, with different modes of action, are mixed to make a single product or formulation, so that the mosquito is guaranteed to come into contact with the two classes at the same time. Mixtures are not currently available for malaria vector control, but might become the future of insecticide resistance management (IRM) once they are available.

These approaches can have different effects on populations of resistant mosquitoes: they can delay the emergence of resistance by removing selection pressure (e.g. rotation) or kill resistant vectors by exposing them to multiple insecticides (e.g. mixtures).

The most practical approach to resistance management is judicious use and high-quality IRS spray application, using different classes of insecticide for IRS and LLINs, and rotating the class of insecticide used for IRS.

Most pyrethroids share common resistance mechanisms. New data is emerging indicating that there may be differences in some of the metabolic mechanisms within the pyrethroid class. For now, however, it should be assumed that changing from one pyrethroid to another will not have any significant benefit in terms of preventing or managing resistance. If cross-resistance between DDT and pyrethroids is found, this implies a knockdown (kdr) resistance mechanism. In this case, an organophosphate or carbamate could be considered as an alternative.

2.4 IRS application equipment: hand-operated compression air sprayers

WHO guidelines are available for hand-operated compression sprayers that are used for IRS application (17):

The sprayer, with fittings assembled, must have no sharp edges or projections that might injure workers during normal operation. Wooden parts should not be used in the construction of any part of the sprayer. The materials of construction, including filler cover, must be corrosion-, pressure- and UV-resistant. The weight of the complete sprayer, when filled to the manufacturer's maximum recommended capacity for operation, should not exceed 25 kg.

2.4.1 Function, components and design

A hand-compression sprayer basically consists of a tank for holding a liquid insecticide formulation, which can be pressurized by means of a hand pump attached to it. The compressed air forces the liquid out of the tank via a hose with a cut-off valve, a lance and a nozzle. Specifications for spray tanks are available through WHO (18).

Tank assembly

The tank itself is usually made of stainless steel. Most tanks have four openings on top: a large one for filling, fitted with a removable cover; and openings for the air pump, discharge system and pressure gauge.

The **tank lid** consists of (i) a rubber gasket seal; (ii) a handle; (iii) a pressure-release valve, operated by hand or by giving the handle a quarter turn; and (iv) a chain to prevent the cover from being lost.

An **air pressure gauge** is used to measure pressure in the tank.

The **shoulder strap** must be 5 cm wide at the shoulder to prevent it from cutting into the shoulder of the person using the sprayer. It is fastened to the tank with steel buckles. Straps must be adjustable in length regardless of tank size.

When the tank is not in use, the spray lance is held in a **bracket** and **nozzle holder**, which protects the nozzle from damage.

Air pump assembly

The compression sprayer is fitted with a manually operated piston pump (plunger) that forces air inside a cylinder. The plunger forces air through a check valve at the base of the cylinder. The plunger seal may be made of leather or rubber, and must be resistant to the chemicals used in insecticide formulations.

Discharge assembly

The main parts are (i) the dip tube, mounted in the tank with an O-ring gasket – if the gasket is damaged, air may leak from the tank; (ii) a flexible hose of a material resistant to chemicals used in pesticide formulations; (iii) a filter with housing which filters out particles too large to pass through the nozzle opening (this can be taken out for cleaning or replacement); (iv) a cut-off

FIG. 5
Cutaway diagram of a compression sprayer to meet WHO specifications

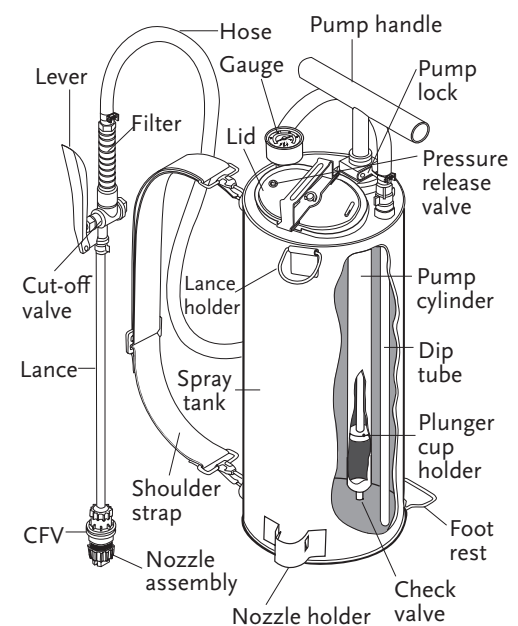

Source: WHO

valve that permits the person using the sprayer to close the system; (v) a lance, or extension tube, 40–60cm in length; (vi) a CFV fitted next to the nozzle, to ensure output of a spray nozzle remains constant as the pressure in the spray tank decreases; and (vii) a nozzle assembly comprising a nozzle tip, filter, body and cap, as indicated in Fig. 5.

Nozzles

The nozzle is one of the most important components of the sprayer. It should deliver a precise amount of spray suspension per minute at a certain pressure (i.e. 1.5 bar), and maintain a uniform spray pattern and swath width. The selection of the nozzle depends on how the insecticide is to be sprayed. The 8002E stainless steel or ceramic nozzles are the standards for flat fan nozzles recommended by WHO for IRS.

The 8002E nozzles emit 0.145 US gallons per minute or 550 ml per minute at a standard 1.5 bar pressure through CFV or 650 ml/min at a 2 bar pressure.

With the 8002E nozzle, a spraying speed of 2.2 seconds per vertical metre on a wall will produce the correct application of 30ml/m². The 8002E nozzle should be kept at 45 cm from the surface being sprayed.

Nozzle flow regulators (constant flow valves)

To avoid a decrease in flow rate, and to ensure an even discharge as tank pressure drops from 55 to 25 psi, it is recommended that flow regulators (i.e. 1.5 bar CFV) are included in the nozzle tip. A compression sprayer with a CFV fitted next to the nozzle is a standard specification for IRS (Fig. 5). A 1.5 bar CFV (also referred as Red CFV) is recommended for IRS. A CFV ensures uniform flow at the nozzle and with a 1.5 bar CFV (Red CFV), the output is reduced and walls are sprayed at 30 ml/m². Applying this volume, the dose rate of product as a.i./m² remains the same and only the water volume is reduced by 25%. By inference, this means that standard sachets of insecticide designed to treat 250 m² of wall surface at 10 litres can then be diluted in 7.5 litres of water and thereby smaller tank sizes can be used. Also, the risk of inhalation of sprays is reduced by using a CFV set at a low pressure, typically 1.5 bar, in contrast to the pressure of 4 bar when the spray tank is fully pressurized and there is no CFV.

2.4.2 Hand compression sprayers and spare or replacement parts

The number of sprayers required depends on the number of spray operators needed to complete the IRS cycle in the allotted time frame. This will depend on the total number of houses to be sprayed, the average number of houses that can be sprayed daily, and the timetable of the spraying campaign. Sprayers should always carry sufficient spare parts for the equipment, and nozzles should be checked for wear at the beginning of every round and replaced as necessary. The best way to assess whether a nozzle needs to be changed is for it to be checked for 1 minute; if the outflow is more than 10% of the normal 550 ml/min for a sprayer fitted with 1.5 bar CFV or 757 ml/min at 40 psi for a sprayer without a CFV, then it is time to change the nozzle. The nozzle life is highly dependent on water quality and need only to be changed when flow rate is too high compared with the normal nozzle rating. Ideally, nozzles should be checked after spraying every 200–300 houses. Spray deposition patterns can be easily checked by spraying water against a contrasting surface (e.g. dry wall). The nozzle should be changed if the resulting spray does not produce a uniform pattern or if the volume sprayed is 10% more than the nozzle rating.

In addition to spare nozzles, programmes should stock other spare parts, especially gaskets, springs and lances, which can be prone to wear and damage. Spare part kits are available from the manufacturers. Spare parts and a system for sprayer maintenance and repair must be included in the annual procurement and planning.

Further details of how to check the sprayer and fill the tank ready for use in the field are given in Section 3.1.3.

2.4.3 Personal protection equipment for spray operators

Spray teams must be provided with adequate materials and these must be procured and delivered with sufficient lead-time to equip teams when they start training and preparing for field operations.

Core requirements for spray operators are:

- insecticides
- 8–10 litre compression sprayers
- sufficient spare parts
- protective clothing.

Additional requirements, depending on the situation, may include:

- tents
- camp beds or sleeping mats
- mosquito nets
- cooking utensils
- lighting.

Programme coordinators must develop and implement an inventory and stock control programme that includes a maintenance plan or replacement schedules for field equipment (e.g. sprayers, vehicles and personal protection equipment). Protective clothing includes:

- broad rim hat (protects head, face and neck from spray droplets);
- full face shields or goggles (protect eyes against spray fall-out);
- face mask/respirator (protects nose and mouth from airborne particles of the spray fall-out and serves to avoid inhalation);
- face shield (protects face from the spray fall-out and splashes);
- long sleeved overalls (keep overalls outside of boots);
- rubber gloves (protect the hands);
- boots (protect the feet); and
- raincoat (protects spray operator when it is raining).

When spray is applied with a tank pressure of 55 psi, a face mask/respirator is essential. With spray applied at 1.5 bar (about 21 psi), when the sprayer is fitted with 1.5 bar CFV, the proportion of inhalable droplets is significantly lower; however, a mask or face shield is required even in a well-ventilated area. A face shield would be more comfortable to wear and avoid the need for goggles. Gloves are necessary when preparing the spray and when spraying the walls, even when using insecticides in sachets where the probability of contamination is low.

FIG. 6
Spray operator protection clothing

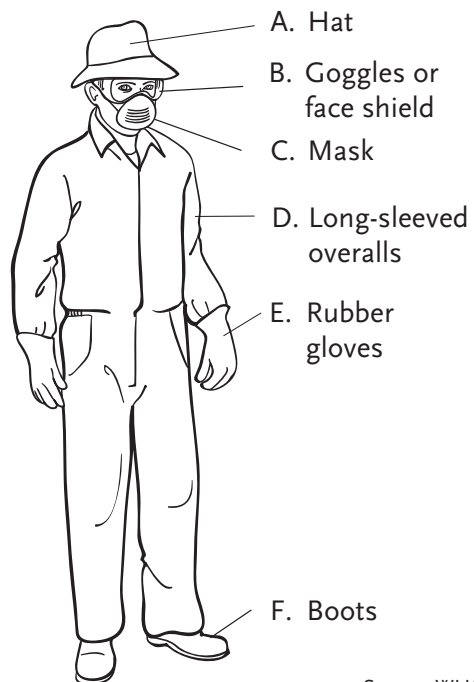

Source: WHOPES

The spray operator should also be provided with the following:

- map of area showing the houses or structures to be sprayed
- notebook and records
- bag/satchel for carrying insecticide bottles or sachets
- muslin cloth for sieving dirty water
- plastic sheeting.

2.4.4 Inventory and maintenance of the equipment

A weekly, or at minimum monthly, inventory of equipment should be conducted during spraying. The final inventory at the end of the spray round should indicate any necessary repairs, replacements or other requirements. Developing and implementing routine daily and weekly cleaning, together with monthly maintenance schedules during spraying, will maximize the life expectancy and performance of sprayers. This is achieved by checking the flow rate of the nozzles as described above. Efforts should be made to provide adequate facilities and equipment for field maintenance and repair of compression sprayers. Sprayers and insecticides are expensive items. Routine cleaning and checking of equipment will prolong the life of the sprayers and ensure the economical use of insecticides. Equipment should be protected during transportation to avoid damage to the tanks and other components.

In order to maintain and repair compression sprayers during and after each spray round, the programme needs to ensure it has identified equipment technicians and provided them with workshops and appropriate tools at designated centres. One member of each district spray team should be given extra training on equipment maintenance and should be responsible for troubleshooting. Training material for equipment maintenance is available in the overall IRS training package available through WHO, or directly from the manufacturers. The same designated person should also prepare an inventory of sprayers and spare parts that will be needed for future IRS campaigns. At provincial level, sprayers are kept in a central location and are repaired by a technician. Alternatively, a technician will visit the sprayer storage facilities at district and, in some cases, subdistrict level.

2.5 Organization and delivery of IRS campaigns

2.5.1 Performance targets

A “sprayable surface” is defined as the inside surfaces of all structures or houses that should be sprayed. This includes eaves not exposed to rain, ceilings, under-floor areas in raised housing, and the inside walls of latrines. Other structures in the village outside the household compounds, and where there are no sleeping areas, such as schools (except boarding school dormitories) and shop houses, should not be sprayed, as these will attract very few malaria vectors.

The minimum spray team operational performance target is 80% of houses, structures or units targeted in any spray round; the ideal is 100%.

2.5.2 Management cycle

An effective IRS programme is based on a well-defined management cycle of operations which is linked to:

- the seasonality of malaria transmission
- the annual health planning and financial budgeting cycles.

FIG. 7
IRS management cycle



The IRS management cycle (Fig. 7) is an effective framework that outlines activities at different stages of the planning and delivery of the spray campaign. It also provides guidance for IRS coordinators and programme managers in the timely management of IRS operations.

2.5.3 Phases of an IRS campaign

The four phases of an IRS campaign are:

- baseline appraisal for new programmes/post-season review for ongoing operations
- pre-season planning, procurement and preparation
- season-implementation of IRS spraying
- end of season recording, reporting and evaluation.

Phase-I: baseline appraisal (new programmes)/post-season review (ongoing operations)

- baseline or annual epidemiological, entomological, demographical and operational situational analysis, including review and surveys of malaria burden and trends, vector ecology, population at risk, and coverage of IRS where available;
- annual update of geographic reconnaissance of target districts, including population at risk, and target household structures or units to be sprayed; and
- operational assessment of insecticides, sprayers, transport, including review of arrangements for stock control, storage and repairs.

Phase-II: pre-season planning, procurement and preparation

- inventory and estimate of annual needs for insecticides, equipment, spray teams, transport, fuel and funds;
- procurement of necessary equipment and insecticides;
- planning and preparation for schedule of spraying;
- organization and logistics for the spray teams, transport, commodities and delivery;
- environmental impact assessment and pesticide management plans;
- plan IRS publicity, IEC and community mobilization; and
- begin recruitment and cascade training of coordinators, supervisors and spray teams.

Phase-III: season implementation of IRS spraying

- distribution of insecticides, sprayers, personal protective equipment and supplies;
- collection of baseline entomological data from both IRS targeted and comparable control sites;
- IRS implementation including supervision and reporting; and
- conduct quality control of spraying using either WHO cone bioassay test or colorimetric assay within 1 week of the start of the campaign.

Phase-IV: end of season recording, reporting and evaluation

- annual review of entomological monitoring and epidemiological surveillance; and
- annual review of IRS performance, documentation and reporting.

2.5.4 Plan of action for operations

The management cycle of operations should be supported by a detailed plan of action (POA). The POA should have strong political support with the required financial and human resource investment to ensure timely procurement of commodities and the establishment of systems and structures, such as a multisector national IRS committee. Policies for requirements such as pesticide registration and compliance with environmental regulations, as well as labour policies for hiring temporary workers, need to be in place. It is essential that there are sufficient personnel with an adequate skills mix to implement effective annual or 6-monthly campaigns and achieve planned objectives.

IRS implementation requires good coordination and tracking with clear timelines. Securing finances and procuring commodities must be planned at least 6–12 months in advance. Spraying should be completed just before the onset of transmission, usually coinciding with the rainy season. Once the rains begin, roads may become impassable for spray teams, and householders may be reluctant to place their belongings outside in preparation for the spray.

The POA should include:

- defining the districts, towns, villages, houses and structures to be sprayed;
- estimating the amount of insecticide, equipment, transport, labour costs and other requirements;
- establishing spraying schedules, both for individual areas and for completion of the whole spraying round. The timing of the spraying should ensure that the residual life of the insecticide being used is at least as long as the transmission season (i.e. that IRS is not applied too early and thereby fails to provide coverage for the whole transmission season);
- clearly indicating the average number of houses or sprayable surface areas to be treated by the spray operator (daily output of spray operator) and number of work-week days;
- calculating financial expenditure and securing financing for operations;
- procuring all materials needed (e.g. insecticides, personal protection equipment, sprayers);
- calculating the number of spray operators, team leaders and supervisors;

- recruiting and training of spray teams;
- assessing the status of transport and fuel, and developing mitigation plans for breakdowns and shortages;
- establishing finance and accounting systems for field operations, including systems for worker payments (e.g. bank accounts and mobile banking);
- arranging for spray team transport as well as transport for coordinators for their supervision duties;
- preparing district and subdistrict malaria camps for storage and base operations;
- preparing clear terms of reference, salary structures and working conditions, codes of conduct and reporting structures for all staff involved in the spraying programme;
- preparing supervision schedules and supervision checklists including those relating to pesticide management and environmental compliance;
- preparing a plan for the collection, accounting and disposal of empty insecticide sachets and containers;
- informing, educating and mobilizing local authorities and communities;
- preparing reporting systems and appropriate reporting forms; and
- tracking progress towards achieving the activities and objectives.

Throughout the planning process, technical goals need to be within the scope of the finances and human resources that are available. There are numerous examples of programme failure due to underestimates of insecticide quantification or of personnel and fuel costs, or where the expected staffing support from partners did not materialize.

The POA should be developed in consultation with experts from the ministry of health (e.g. in the areas of epidemiology, entomology, human resources, finance and logistics) and other ministries, such as agriculture and the environment, as well as national pesticide regulatory authorities, partner NGOs and private-sector entities. There must be open communication between the IRS staff, the rest of the health system and the community. A timeline for implementation of IRS is available in Annex A1.4 and an RBM IRS Toolkit is also available at http://www.rollbackmalaria.org/microsites/archive/newsletters_2006_2015/tool_irstoolkit.html

2.5.5 Financial planning for IRS

The annual cycle of IRS operations requires preparation of financial plans or proposals based on estimated needs of insecticides, equipment, human resources, logistics, travel, per diem for coordinators and supervisors, etc. These estimates are based on the number of spray rounds per year, the number of houses, rooms or structures to be sprayed and the planned duration of the spray campaign.

2.5.6 Costing, budgeting and financing

Every IRS operation must have a budget for:

- baseline and routine entomological monitoring;
- mapping and geocoding of target areas;
- insecticide and equipment, including sprayers and personal protection equipment;
- supplies such as tools, spares and replacement parts;
- transportation (vehicle rental, fuel, insurance, drivers);
- warehousing, camp or staging areas and maintenance repair facilities, including lease and site management costs;
- staff salaries, per diems and benefits;
- partnership collaboration, including advisory committees and entomological monitoring networks;

- managerial costs; and
- contingency funds.

As outlined in the framework for IVM, programmes should aim to optimize resources for vector control including, where possible, collaborating with other ministries, with civil society and with the private sector to enable an efficient and cost-effective IRS operation. The plan should include identifying sources of funds and in-kind contributions (such as warehousing and transport), whether from central government, local government budgets, or other sources.

A contingency fund, generally estimated as 10% of overall budget, should be available in the event of there being more targeted structures than initially estimated, or of price increases in fuel, salaries or insecticides. An example of capital and operational budgets for IRS can be found in Annex A1.5.

2.5.7 Checklist for tracking POA implementation

IRS implementation requires careful tracking with clear deadlines for completion of activities before the start of the malaria transmission season. A checklist will help ensure that all areas of the programme are in place or have been duly considered.

2.5.8 Timing and duration of spray rounds and cycles

The timing of spray rounds is critical and depends on the seasonality of vector populations and malaria transmission. These are related to weather, especially rainfall, humidity and temperature. Spraying cycles can be designed to control one major peak transmission in low- to moderate-transmission areas or for year-round transmission in high-transmission areas. Ideally where rainfall season is a defined period of 4–5 months, the IRS cycle should be completed in the one month prior to the first rains.

Spray round

Effective spray round implementation should be:

Total: all the dwellings are sprayed;

Complete: all sprayable surfaces are covered;

Sufficient: uniform application of the required dose to all sprayable surfaces; and

Regular: spraying should be at regular intervals so as to ensure that an effective residue is in place during the whole malaria transmission season.

Spray cycles

The spray cycle is the time between consecutive spray rounds. If the malaria season lasts only 3 months and the insecticide used persists for 3 months or more, then spraying should only be done once a year. In areas where malaria transmission occurs throughout the year, at least two spray rounds may be needed to cover the whole transmission period. However, DDT and new capsule suspension (CS) insecticide formulations have been shown, in some areas, to last more than 10 months. In areas with perennial transmission, where there is high LLIN coverage, it may not be necessary to apply two rounds per year. If a single spray round is carried out, it should target the major peak transmission period.

Ideally, spray operations should be completed in less than 2 months with a weekly work routine of 5–6 days on and 1–2 days off. Programmes need to ensure adequate numbers of spray operators to complete the spray round within the stipulated time.

The seasonality of onset of the rains (and malaria transmission season) often varies from one part of the country to another. Monthly malaria surveillance data should be analysed and areas stratified to ensure that the critical areas are sprayed before the onset of the rains.

2.5.9 Programme organization

In most country settings, the national malaria control programme should direct and coordinate provincial or state IRS operations. A vector-control officer should be designated as the IRS focal person at each level. Central or provincial technical support in entomology and epidemiology should be made available during the planning, monitoring and evaluation of district IRS operations. The national and provincial IRS focal points should be supported by a national vector-control or IRS vector-control technical advisory committee and a network of research and academic institutions with a central entomology laboratory.

Responsibility for planning and decision-making and other aspects of malaria control depends on the administrative structures of the central and local governments. Responsibility for implementation may be localized at the district level, regionalized and completely vested in the ministry of health, or may be shared, at the district level, with local government structures such as local councils, municipalities and town boards.

Organizational chart

In order to calculate the human resources needed, an organization chart should be developed. The organization will depend on the size of the area to be sprayed, the distance between target houses, the difficulty of the terrain, and the target time frame for completion of the spray round. See Annex A1.7 for examples of IRS operations organizational charts.

IRS multisectoral task force

IRS is a labour-intensive field operation. In order to ensure that multisectoral coordination concerns are addressed a task force needs to be assembled. This will comprise high-level policy-makers across sectors such as ministries of local government, agriculture, environment, transport, communications, education, finance and labour. This task force should ideally meet quarterly during the preparatory periods and monthly during the 2-month spray period.

Vector-control technical advisory committee

An advisory committee should be established, made up of members of the national vector control unit, and with the national IRS coordinator in the malaria department to provide support on policy, technical and programmatic issues. They will also provide guidance on selection of districts for IRS and of insecticides and equipment, and on monitoring of coverage rates and will provide support for spray round reviews and programme evaluations. The advisory committee should also include representatives from other sectors such as ministries of environment and agriculture, as well as representatives of the private sector (who may support IRS as part of their workplace protection programme). The committee should meet regularly during the preparatory planning period for each spray round in order to ensure timely preparation of estimates of insecticides and financing. It should then meet as frequently as necessary during the spray round to ensure timing and quality are maintained.

Provincial or state and district malaria control officers, as well as IRS coordinators, should be invited to meetings to review the planning and implementation progress as well as to identify and propose solutions for problems that arise in the field.

The structure and organization of campaigns may vary from centralized programmes with operations managed at the national level, to decentralized programmes where operations are managed at the provincial or district levels. There have been some programmes (e.g. in Ethiopia) where IRS has been successfully managed at the community level by health extension workers, with two workers per village of 5000 people. The main role of these health extension workers has been to lead health promotion and preventive activities. After being trained in IRS and provided with

insecticide and with personal protective equipment and spray equipment, the health extension workers then recruited, trained and led spraying in their catchment areas.

The IRS structure may be part of the national ministry of health system or may be part of local government, such as district, town or municipal councils. In all situations it is important to develop organograms illustrating the location of staff according to duties and as a way of visually linking duties to individuals. The IRS structure is summarized in Table 5 below.

TABLE 5
IRS operations structure and systems

LEVEL OF HEALTH SYSTEM	RESPONSIBLE OFFICER	TASKS
National	National IRS coordinator (1) National entomologist (1) Data manager (1) Financial manager (1) Logistician (1)	• Overall quality control
		• IRS policy
		• IRS proposal and plans
		• IRS guidelines
		• Monitoring and evaluation
		• Budgeting and securing finance
		• Managing finance and accounting systems
		• Estimation of commodities and transport needs
		• Managing central stores and stock control
		• Training provincial and district coordinators
		• Central procurement and quality control
		• Support for vector sentinel sites (vector ecology, bioassay, susceptibility studies)
		• Operational research
Provincial	Provincial IRS coordinator (1) Provincial entomologist (1)	• Plans of action
		• Developing and evaluating information education and communication (IEC) materials
		• Coordination and supervision
		• Monitoring and evaluation
		• Cascade training district supervisors
		• Equipment repairs
District	District IRS coordinator (1) District IRS operations coordinator (1) Entomology technician (1) Data manager (1) and data entry officers District IRS logistician and equipment technician (1) District finance and payroll officer (1)	• Plans of action
		• Monitoring and evaluation of field operations
		• Budgeting and securing finance
		• Managing finance and accounting activities
		• Estimation of commodities and transport
		• Stores and stock control
		• Equipment inventory and repairs
		• Selection and recruitment of field team
		• Field training of team leaders and spray operators
		• Supervision
		• Reporting
• Running vector sentinel sites (vector ecology, bioassay, susceptibility studies)		

Responsibility at national level

The national malaria control programme manager coordinates the overall programme implementation with responsibilities delegated to a national vector-control or IRS coordinator working with the national entomologist. As outlined above, the national coordinator is usually supported by a national vector-control or advisory committee, and by a national research institution with a central entomology laboratory.

Duties at national level include:

- preparing national IRS proposals, planning, coordination, formulation of policy;
- setting standards and preparation of operational guidelines;
- providing IRS technical advisory services and providing feedback for remedial action where appropriate;
- maintaining a database on epidemiological, entomological, demographic and operational information with integrated GIS;
- managing of resources for IRS by defining specifications and procuring insecticides, sprayers, transport;
- securing staffing and financing;
- managing the finance and accounting systems for operational field costs (note in some countries this is managed at the local government level);
- organizing distribution of supplies, including insecticides;
- monitoring and coordinating all IRS activities carried out by the provinces/states and related agencies and providing feedback for remedial action;
- ensuring IRS multisectoral cooperation;
- identifying IRS training needs and organizing training of trainers (TOT) sessions; and
- planning IRS operational research (when required) and collaborating with research institutes and universities.

Responsibility at provincial/state level

The provincial malaria control officer and an IRS officer coordinate the implementation of the IRS programme in all the districts and help to put policies and guidelines from the national level into practice.

Duties at provincial level include:

- planning and management of IRS operations in target districts;
- providing estimates for operational requirements of insecticides, equipment, human resources and finance at provincial level;
- providing support and training to district coordinators;
- providing scheduled supervision of IRS district coordinators;
- taking responsibility for tracking implementation in each of the districts;
- reporting on coverage and quality of IRS in districts; and
- supporting district entomological monitoring (vector types and susceptibility).

Responsibility at district level

The district health officer, district malaria coordinator or district IRS coordinator is in charge of the implementation of all IRS operations and activities within the district. At operational level, IRS activities are managed through the subdistrict field coordinators and malaria spray team group leaders.

Duties at district level include:

- implementing day-to-day running of IRS operations;
- recruiting and managing IRS control personnel;

- coordinating and/or conducting annual training;
- costing, budgeting and financial reporting;
- managing payroll, local rentals and other operational costs;
- estimating overall operational requirements of IRS in the district;
- monitoring and evaluation of the quality of interventions;
- updating geographical reconnaissance information;
- ensuring security and safe use of insecticides, equipment and transport; and
- implementing IEC activities.

Ministry of environment and ministry of agriculture representatives should ideally be included on the district supervision teams, especially in countries using DDT, to make sure the insecticides are managed properly and that all rules and regulations on safe use and disposal are followed. Involvement of ministry of agriculture personnel with experience of spraying crops is important to provide training and supervision. Likewise, country environmental protection agencies will be useful to provide training on proper handling and disposal of chemical waste.

Supervision

District IRS coordinators should directly supervise operations at ground level. Provincial coordinators should oversee monthly operational review meetings and give appropriate guidance to the district coordinators. Spray operations are logistically and technically demanding and it may be necessary for provincial and national coordinators to maintain strong vertical tracking and close supervision to ensure quality implementation of IRS programmes.

Organizing spray teams

In order to achieve greater than 80% spray round coverage in a timely annual implementation (usually less than 2 months), programmes must include an adequate number of IRS teams, each of sufficient size and with appropriate field supervision and district coordination, as outlined below

At the planning stage, the number of spray teams required should be calculated based on the time available to conduct spray operations; the total number of housing structures or units to be sprayed; and the number that can be completed by one operator in one day, taking into account the travel distance between structures and the actual size of the sprayable surface per structure. Spray teams may be allocated specific areas to spray in each district. This is done to ensure that every village is covered and that teams do not have unmanageably large areas to spray, which could lead to spray operators being so dispersed that supervision and re-supply becomes a problem. Detailed spraying schedules showing planned movements, activities of spray teams, the site of malaria camps, and areas for IRS should be mapped out. It is important that community, leaders and local authorities are consulted when preparing these schedules. In some cases, the target spraying areas will be close enough to the homes of spray operators, such that they can carry out their work during the day and return to the central depot, clean and store their equipment, and return to their homes at night. Involvement of operators from the local community, rather than strangers from another part of the country, will improve acceptance and compliance and reduce cost of transportation.

Number, size and composition of spray teams

The number of spray teams per district is 5–10, depending on how many structures need to be sprayed during a 6–8 week spray campaign.

A *single spray team* is one unit and the number of spray teams required depends on the areas that have to be covered. The composition of a team is as follows:

- *one team leader* whose function is to record and report on the households and housing rooms/ units to be sprayed and on those missed for follow-up mop-up spraying;
- *5–10 spray operators* (with smaller teams highly preferable in cases where the personnel are less experienced and require greater supervision or where the areas to be covered are spread over a wide geographic area), each with their own compression sprayer and an adequate supply of insecticide charges for the day;
- *1 ‘warner’* or community mobilizer. This is a role undertaken by a paid casual worker who communicates with local leaders and who also informs the householders that the spray is about to take place so that they can make the necessary preparations;
- *1 driver* with a vehicle capable of safely and comfortably transporting the spray team, their equipment and approximately 250 litres of water; and
- *1 group leader/ supervisor* to coordinate 3–5 spray teams.

In cases where households are both easy to access and near to each other, one spray operator should be able to spray 8–10 (up to 15 in some locations) households a day. This may fall to as low as 5 per day in areas where houses are scattered and separated by long walking distances or where there are very large houses.

The number of houses in each district divided by the number of working days in the 2- or 3-months spray round time frame equals the number of houses to be sprayed in each working day. This number, divided by the number of houses that can be treated per spray operator per day, gives the required number of spray operators for that district. Assuming a five-and-a-half day working week (with Saturday afternoon and Sunday off), there will be 48.5 work-days in 2 months, assuming there are no holidays during this period.

The number of spray operators required for a 2-month spray cycle should include a 5% cushion to allow for absences and unforeseen events.

District and subdistrict coordinators, in consultation with community leaders and local authorities, are required to recruit spray operators and train them to handle insecticides safely and to accurately apply insecticides under local conditions.

Spray team leaders and squad/group leaders or supervisors must check that the amount of insecticide sprayed on walls is sufficient and completed according to recommended standards. Spray teams should be instructed to implement total coverage of all units and rooms. This entails searching out and spraying every single sprayable structure.

Spray operators are often casual workers or individuals who are employed from a community district for just 2–3 months. This period covers both training and implementation of the spray operation. The contracts for these operators may be done through the ministry of health or any local authority. In some situations an implementing partner (such as a bilateral donor, an NGO or a private-sector company) takes responsibility for IRS. Spray operators should be at least 18 years old, be physically fit and healthy, have no obvious disabilities that would limit their mobility, be able to read and write the national language (so they can read the label and follow emergency procedures if needed), and be able to operate the sprayer. The operator should be a responsible person who can work under minimum supervision. Women who are breastfeeding or are pregnant are not able to work as spray operators. In addition, any woman who becomes pregnant during the campaign should be reassigned to duties other than spraying.

Spray team members have a duty to always act in a professional manner towards each other and maintain good relations with the local community members. For this reason it is preferable for spray operators to be drawn from their own communities and vetted by the community members. Their behaviour and demeanour should be beyond reproach. A “code of conduct” for spray operators and team leaders is included in Annex A1.6 (19).

Daily routine of spray teams

The daily routine of a spray team includes the following.

- The spray team leader checks the spray team every morning to verify that they are all wearing clean protective clothing, and provides them with a briefing of where they will be spraying that day.
- Each spray operator prepares his/her hand-compression sprayer for review and inspection by the spray team leader. In addition, the spray team leader ensures that the spray operator has all the necessary personal protection equipment and that it is in good working order.
- The spray team leader checks the amount of insecticide in numbered sachets that each spray operator requires for the day and ensures that he/she has all the necessary information and recording forms for the day's work.
- The spray team then proceeds to work using the transport assigned.
- Upon arrival in a targeted village, the spray team leader allocates a number of houses to each spray operator.
- The spray team leader arranges sleeping accommodation with the community leader if the team are required to stay overnight in the village. In some areas, teams will establish malaria field camps and will be provided with camping equipment.
- At the completion of the day's work, the spray team leader ensures that each spray operator properly and safely disposes of any remaining insecticide in his/her sprayer following the progressive rinse method, and that he/she thoroughly cleans his/her sprayer at a designated wash point.
- The spray team leader will run the evening debriefing and check on insecticide use, on the return of empty sachets and on the handing in of daily recording forms.

Occupational protection and safety for IRS spray teams

Spray operators are required to wear protective clothing when handling insecticides and during all spray operations. Absorption of insecticide occurs mainly through the skin, lungs and mouth. Specific protection clothing must be worn in accordance with the safety instructions on the product label (see Section 2.4.3).

Upon completion of the day's activity, all protective clothing, including boots, should be washed. If overalls are accidentally contaminated, they should be removed immediately and washed as soon as possible.

Supervising spray teams and spray operations

IRS requires guidance and support from all involved senior officials at district, provincial and national levels, especially the IRS coordinator. This support and supervision should be provided routinely and consistently throughout the period of the spray round. Inspections should be carried out using standard forms and checklists to ensure uniformity and accuracy

Spray operators and teams should be constantly monitored to ensure that team tasks are on schedule, that there is a high quality of spraying of individual housing units, and that coverage is high.

Purpose of supervision

The overall purpose of supervision is to ensure that high-quality IRS is delivered and that high coverage is achieved. Specifically, supervision aims to:

- ensure that the planned work schedule is strictly adhered to
- take corrective measures on the spot, especially where technical deficiencies are concerned
- stimulate, encourage and advise on effective functioning of the fieldwork

- ensure that strict discipline is maintained
- assess, evaluate and acknowledge the work output of individuals
- make recommendations, report and follow up.

Supervisory tools

Supervisory tools include forms, reports, records, graphs and charts to monitor operations. See Annex A1.14 for a sample supervision checklist. An IRS supervision inspection checklist (such as the one provided Annex A1.14), is intended to be used as a supervision tool to verify country programme preparedness to safely implement IRS and minimize environmental contamination. This checklist is divided into sections to cover all the different stages of an IRS operation: 1) pre-spraying store/soak pit inspection; 2) spraying activities inspection; and 3) post-spraying wash-up/waste disposal activities. The checklist can be used to verify, for example, that spray operators have access to, and are trained to use, personal protective equipment to ensure their safety; sites used for IRS operation have a well-managed warehouse including a soak pit or soak away that is used for progressive rinsing of spray tanks and washing of personal protective equipment; and plans are in place for the handling and disposal of chemical waste to minimize or avoid environmental contamination. At any stage of an IRS operation assessment, feedback should be provided and should draw attention to areas that require attention. The feedback should also propose solutions and recommendations to the IRS district coordinator or supervisor who should ensure corrective measures are taken.

Training for IRS coordinators and spray teams

A successful IRS spraying campaign depends on the application of an adequate and uniform dosage of insecticide on all possible resting places of the adult female mosquito. This requires appropriate training of spray operators, team leaders and group team leaders or supervisors, as well as subdistrict and district coordinators.

Institutional training for IRS coordinators

Formal IRS training of trainer (TOT) courses for district, provincial and national IRS coordinators should be conducted by the ministry of health and implementing partners as short practical courses and workshops. Generic IRS training materials are available through WHO, RBM and the US President's Malaria Initiative.

This training should include the following topics:

- understanding what IRS is – why, where and when it is use
- the role of baseline entomological surveys
- conducting GR and census of spray areas and houses or structures
- insecticides used for IRS and related safety precautions
- spray application equipment, its maintenance and inventory
- developing an IRS POA
- conducting a house spray
- tracking, supervising and implementing spray rounds
- reporting on progress and performance of an IRS campaign
- principles and requirements for safe and appropriate pesticide management.

Field training for IRS supervisors and spray operators

Field training of all spray operators immediately before the beginning of each spray round must be provided. The technical skills of spray operators, team leaders and group leaders or supervisors must be updated regularly. Malaria programmes should establish field training centres strategically placed in the districts for this purpose.

The annual practical training of spray operators should focus on developing the necessary skills for adequate spraying, especially spray timing, spray pattern, deposition overlap, and personal and environmental safety.

The training course should be subdivided into several sections and should take place over 5–7 days. No time-limit should be set on how long each individual section takes to complete, as this will vary according to the trainee's readiness and skills. However, 3–5 days should be dedicated to the practical portion of the training.

The purpose of training should be to ensure all personnel involved in IRS understand their tasks and responsibilities and are made aware of their responsibility to their colleagues, the environment and the community. They undergo training to enable them to grasp the concepts of:

- what IRS is and why, where and when it is used;
- the insecticides and their safety precautions;
- the use of spray equipment, its handling, care, transportation and storage;
- dismantling and reassembling a sprayer;
- preparing the sprayer;
- sprayer pressurization and calibration;
- preparing a house for spraying;
- sequence of spraying in a house;
- how to complete the house spray cards and required daily reporting forms; and
- how to explain the objectives of the IRS programme to householders and how to answer any questions asked.

Training wall

The practical training of spray operators preceding each spray cycle includes, among other activities, spraying of a training wall with water. The IRS training wall helps operators to focus on two areas: teaching them how to maintain the exact distance from the nozzle tip to the surface being sprayed; and how to spray at the correct rate and keep up the speed of application over the surface. To accomplish this:

1. The trainer marks an area 3m high and 6.35 m long, divided into 9 bands, the first one 75 cm wide and the remainder 70cm wide. The spray nozzle will provide a spray swath or spray pattern 75 cm wide if kept at a distance of 45 cm from the wall.
2. To practise keeping the nozzle 45 cm from the wall, a wooden or plastic extension is fitted to the lance. The length from the nozzle tip should be 45 cm.
3. The spray operator stands directly in front of the wall, with right arm extended and body inclined towards the surface while raising or lowering the right arm so that the end of the stick remains in contact with the surface.
4. The spray operator starts at the top corner of the wall and sprays at a uniform rate, moving downwards to the bottom. He/she takes one step to the right and continues spraying. The next swath should overlap with the previous one by about 5 cm. The operator should spray down to the bottom.
5. At the end of each swath, the spray operator stops the flow of insecticide and steps 1 m to the right.
6. The spray operator continues in this way until the entire area of 19 m² is covered. Each swath of 3 m in height should be covered in about 7 seconds, or 9 swaths in 1 minute to cover the whole area.

Spray training practice

During the training, spray operators should try working under real conditions in order to practise spraying different parts of a structure such as wall space, above and below heavy furniture, and ceilings.

Training of team leaders and supervisors

The first-line group leaders should be trained to carry out the same tasks as the spray operators. In addition, they should be trained to carry out GR, record keeping, reporting, public relations and sessions on basic health messaging related to malaria and IRS. This will enable them to provide supervision.

2.5.10 Equipment and logistics for spray teams

IRS spray teams require that sufficient materials and supplies be procured and delivered in time for training and preparation for field operations. Core requirements are insecticides, hand-compression sprayers with adequate spare parts, and protective clothing for spray operators. Other equipment for spray teams may include tents, camp beds, sleeping mats, mosquito nets, cooking utensils and lighting.

IRS coordinators must develop and implement a stock inventory with a maintenance plan or replacement schedules for field equipment (hand-compression sprayers, vehicles and personal protective equipment). (See also Section 2.4: IRS application equipment.)

2.5.11 Transport

IRS operations require vehicles for moving equipment, materials and personnel over different areas of a district during the period of the spray round. Given the difficulties of accessing many areas during the rainy season, it is best that spraying rounds are completed before this begins.

Spray teams have to be moved between malaria field camps and between different locations during spraying operations in order to cover all households. The minimum requirement is one to two 3–5 ton trucks per district to service 5–10 spray teams. When areas to be covered are small and the number of teams is small, a 4x4 pickup may be assigned to one spray team to carry the operators, spray equipment and materials. Supervisors and district coordinators should be provided with motorcycles. Provincial and national coordinators should be provided with 4x4 pickup vehicles.

2.5.12 Communication equipment

To improve management, supervision, tracking and reporting of spray teams, the use of VHF radio-communication or a cell phone system for district coordinators, supervisors and group leaders should be considered.

2.5.13 IRS field camps

As each district will have 5–10 spray teams that move around different areas over the 2–3 months of the operation, it is important to set up temporary field camps at strategic locations. Some of these field camps may also become permanent storage, equipment repair and training facilities for districts and provinces.

2.5.14 Site consideration and specification of a soak pit

A soak pit is a specially-designed hole in the ground for disposing of biodegradable waste (e.g. waste from pyrethroids, carbamates and organophosphates). It protects the environment from contamination while allowing pesticides to degrade (20).

Site considerations

Sites for locating IRS cleaning and waste facilities (progressive rinse, soak pits and wash areas) should consider topography, potential for groundwater contamination, and proximity to water bodies (rivers, lakes and wetland) with a view to avoid potential contamination of groundwater with insecticides. The following should be taken into consideration:

1. Avoid areas with high groundwater table and areas prone to flooding, and choose sites away from bore holes and schools whenever possible.
2. If possible, avoid locating near crops, surface water, animal enclosures, beehives and public buildings.
3. Particles and biomass can clog the soak pit and will need to be removed periodically.

Standard design and construction

A soak pit measuring 2 m by 1 m by 1 m is usually sufficient to absorb the effluent produced from 20–30 spray operators for the duration of the spraying operations. The pit walls should be lined with a plastic sheeting to prevent seepage of chemical effluent through side walls. The bottom of the pit is lined with 1 to 1.5 bags of sawdust, covered with 1.5 to 2 bags of hard coal or charcoal, covered with a layer of stone aggregates and small gravel to create a filter. As the effluent percolates through these materials, the pesticides filter out and degrade before reaching the surrounding soils. All staging areas used for washing spray equipment and personal protective equipment are required to have an impervious wash area that drains to the soak pit. This is necessary to avoid possible ground contamination. The entire soak pit area is fenced in with a lockable access door to prevent unauthorized entry by children or animals. Unless the soak pit becomes clogged with foreign matter and will not drain, it should remain effective for 3 years, at which time it can be excavated so that the sawdust and coal can be replaced.

Siting

Soak pits should be co-located with both the progressive rinse area and the wash area. This is to avoid potential spills when transporting effluent to the pit. Due to distance and access limitations of some spray sites, it may be more appropriate to create a scaled down version of the soak pit located near the site, or a mobile soak pit.

Decommissioning

Restore to former condition by filling in, levelling and planting the area with appropriate local vegetation.

2.5.15 Evaporation tanks

An evaporation tank is a sealed tank for the disposal of non-biodegradable liquid pesticide waste such as DDT (20).

Standard design and construction

An evaporation tank should hold approximately 15 750 litres (based on the amount of effluent produced each day minus evaporation rates), which should be sufficient to allow disposal of effluent from 20–30 DDT spray operators. The tank should be designed to have maximum surface

area to promote evaporation. The larger the surface area, the faster the liquid in the tank will evaporate. The tank should be constructed with concrete, sunk into the ground with sides raised 20–30 cm high, covered with a lockable wire mesh and located on the downward side of the rinse area. Once evaporation is complete, the dried DDT residue is collected and then disposed of, together with the other solid DDT waste. The tank should be located downhill from the progressive rinse area so that run-off from this facility can be directed into the tank.

Proper use

- After a spray round, all of the sand, sludge and pesticide residue remaining in an evaporation tank should be scooped out, placed in a sealed container, placed with empty sachets, and disposed of according to country protocol for solid waste disposal.
- If it rains during spraying operations the tank should be covered with a tarpaulin to prevent extra rainwater from flooding the tank and causing overflow.
- If the water level in the tank comes within 6 inches of the drainage hole, liquid should be siphoned into plastic polytanks (around 4000 litres) for temporary storage, until it can be added back into the tank.

Decommissioning

If evaporation tanks are to be decommissioned, all DDT residue should be removed before the tank is dismantled, and the site should be restored back to its natural state as far as possible once IRS activities discontinue permanently. Disposal of chemical waste should follow international standard (Section 2.3.6).

2.6 Information, education and communication; community mobilization

The public needs to be kept well informed to ensure full support and cooperation with any IRS activities. IRS programmes should always have an effective advocacy and public health promotion component to ensure widespread acceptance and support at household and community level. This requires an ongoing dialogue between those coordinating IRS programmes and community and local government leaders, together with other sectors such as local government, agriculture and education. Professional guidance should ideally be sought from health educators, health promoters and social scientists to develop information, education and communication (IEC) strategies and to conduct IEC campaigns before the start of each spray round. Focus group sessions should be held to define how IRS is justified to the public, to anticipate areas of concern, and to develop key messages.

2.6.1 IRS advocacy

IRS constitutes a public health service that is provided at regular intervals to every household. It is labour intensive and, when properly implemented, lends credibility to health services and to government. As such, it has political and policy-setting potential, which can be maximized through periodic IRS campaign launches and IRS campaign closing ceremonies held in strategic locations and featuring national and international celebrities.

2.6.2 IEC campaigns

IEC campaigns should be carried out before spraying operations are launched countrywide or in specific districts in order to raise awareness around IRS; facilitate community mobilization; ensure acceptance of IRS; and encourage participation in IRS operations at the family and household level.

IEC campaigns use simple messages that are consistently reinforced through different media. Educational materials such as pamphlets, posters and cartoons need to be produced and widely distributed. Where possible, these should be supported by radio and TV spots.

Meetings organized by community leaders to explain the procedures and benefits of IRS programmes should be one of the tools used in health education and should include:

- how insecticide application impacts on malaria, including the duration of activity on the sprayed surfaces;
- the fact that spraying does not harm walls, ceilings and furniture;
- the fact that spray operators are responsible people who will take care of people's property;
- the need for the participation of householders in preparing their houses for spraying and complying with instructions;
- the fact that insecticides used are not hazardous to humans, dogs, chickens, cats or other domestic animals, if the precautions outlined by the spray operator are followed; and
- instructions to house owners not to re-plaster or wash sprayed walls for a few months after spraying and until the peak malaria season is over.

2.6.3 Community participation

For a spraying programme to be successful, people must be informed of the benefits of protection against malaria-carrying mosquitoes that is afforded by IRS. The higher the percentage of houses completely sprayed with residual insecticides, the better the protection afforded to the entire community.

Target groups for community mobilization include:

- traditional leaders
- political leaders
- religious leaders
- civil society leaders
- women's group leaders
- youth leaders
- school children.

Every effort must be made to enlist the cooperation of each household. This requires obtaining community leaders' and householders' agreement before initiating an IRS programme in a locality/village. There should be opportunities for community members to debate issues, seek advice and arrive at a consensus of opinions and approaches. Community meetings should emphasize the procedures of an effective programme. Ideally, local spray operators should be employed or a local community leader or resident should accompany spray teams to secure full householder cooperation.

Household and community cooperation with spray teams is needed to:

- assist in ensuring water is made available for mixing insecticides;
- assist in clearing and covering household furniture before spraying;
- allow evaluation procedures to take place and, if required, assist with the set-up and management of mosquito window traps or CDC light traps; and
- take an active role in the execution of IRS to make sure it is done on time and ensure all household structures are treated by the spray operator.

2.7 Reporting on progress and performance

Efficient and accurate reporting is a critical element of any IRS program. It is critical for gauging the effectiveness and efficiency of the programme and is vital to its sustainability.

Accurate recording during the planning and implementation of an IRS campaign will generate information on management effectiveness and performance in terms of coverage and impact. The main activities related to this are:

- daily recording and weekly and monthly reporting on structures and populations covered, amount of insecticide used, problems encountered in implementation and proposed solutions. Note that some programmes implement daily summaries by telephone from the team leader to the district manager to report key indicators and spray operator daily output;
- review of IRS spray operations, calculation of structure and population coverage;
- monthly assays on the quality of IRS at sentinel sites or villages;
- regular entomological monitoring at sentinel sites or villages, including vector composition and density, and feeding and resting behaviours;
- insecticide susceptibility monitoring, on an annual basis at least;
- planning and financing of subsequent IRS spray rounds; and
- updating GR and mapping records.

In order to facilitate efficient recording and reporting of information, clear and simple data collection forms, entry forms, analysis tables and report templates should be developed. Hand-held PDAs and computers with spreadsheet, database and mapping software can be used to speed up manual data recording, storage, analysis and reporting. This will contribute to rapid, efficient and effective management.

2.7.1 IRS programme performance

Malaria programme managers, IRS coordinators, group team leaders and field supervisors must track the performance of IRS interventions in order to assess their progress in relation to targets. These targets are primarily coverage of the targeted rooms or structures, households and population at risk from malaria. Epidemiological impact should be monitored through health management information systems (HMIS) or sentinel facilities.

The main outputs of IRS are:

- number of rooms and structures sprayed and unsprayed as compared to the target number;
- number of people protected through structures or houses sprayed.

The objective of an IRS spray round is to achieve a minimum of 80% coverage of targeted structures, houses and population at risk.

2.7.2 Methods of programme performance measurement

Entomological baseline surveys on vector density, distribution, biting and resting behaviours, and susceptibility, must be conducted before IRS begins (see Section 2.2). This supplements the situation analysis through rapid review and collation of existing information from past programme records, other surveys and research studies.

Routine reporting relating to IRS access and coverage should be undertaken, with reporting forms completed daily, weekly and monthly by spray operators. During spray operations, these reports are used to track and report on structure, house and population coverage indicators. Daily supervision of spray operators by team leaders and supervisors should be conducted to ensure they comply with standard operating procedures.

Provincial and district coordinators should conduct random sample surveys of one in 10 households to cross-check the validity of reported coverage, the quality of spraying, and householder perception.

WHO cone bioassays (preferably using susceptible anophelines from insectaries) should be used to measure the quality of application of spray. If this is not possible, field-collected susceptible anophelines can be used. Colorimetric assays, which do not depend on live mosquitoes for a bioassay, are under development. These will be able to quickly quantify in the field the amount of insecticide on the wall surface. When they become available, these colorimetric assays should enable programmes to increase the speed and ease of quality assurance of IRS programmes.

Insecticide susceptibility testing should be conducted annually, to verify that the insecticide being used is still effective.

Field entomology teams are required to assess operational effectiveness in different areas and to manage sentinel sites in different ecological zones. These sites enable the teams to monitor and detect changes in trends in vector composition, density, behaviour and susceptibility.

IRS coordinators should seek support to establish central and field insectaries. They should also collaborate nationally and internationally with research or academic institutions and with insecticide-resistance networks to support the above areas of performance measurement.

2.7.3 Routine operational performance indicators and performance targets

Once a spraying operation has been carried out, checks must be made to ensure that the spraying coverage is complete, that no structures have been missed, and that all sprayable surfaces within those structures have been covered. Every effort must be made to ensure good supervision of the spraying operation and that an efficient recording and reporting system is in place.

Coverage

The percentage of houses and rooms sprayed in relation to the targeted number of houses or rooms should be regularly calculated. Coverage below the pre-defined target indicates operational shortcomings and appropriate action should be taken to overcome constraints and achieve high

TABLE 6
Core IRS operational performance indicators

NO.	INDICATOR NAME	METHOD	FREQUENCY	APPLIED TO
1	Number of structures/houses to be sprayed and not sprayed (number of structures/houses sprayed)	Malaria programme IRS reporting system	Daily and weekly	Structures/houses
2	Proportion of structures/houses sprayed in relation to those not sprayed (proportion of structures/houses sprayed in relation to those targeted for spraying)	Malaria programme IRS reporting system	Daily, weekly and end of spray round	District, province/region, country, global
3	Proportion of structures/houses not sprayed in relation to those targeted for spraying	Malaria programme IRS reporting system	Daily, weekly and end of spray round annually	District, province/region, country, global
4	Number of people living in structures/houses which have been sprayed	Malaria programme IRS reporting system	Daily and weekly	Structures/houses
5	Proportion of population at risk of malaria protected by IRS	Malaria programme IRS reporting system	Annual	District, province, country, global
6	Proportion of districts at risk of malaria covered by IRS	Malaria programme information system	Annual	Region, province country

coverage. The proportion of houses re-plastered or missed (or closed) during spraying needs to be recorded and followed up with mop-up operations.

Calculating coverage

The number of houses or structures that have been sprayed or left unsprayed will be derived from daily and weekly spray operations reporting. The coverage is calculated by dividing the total number of houses or structures actually sprayed during a round by the total number of houses or structures that were targeted or found.

Malaria IRS house spray cards

A household record card should be given to each household during the GR and census, and should be updated during every spray round. It should include the house location and identification number, name of the head of household, number of residents, number of rooms, date of spray, insecticide used, and names of the spray operator and team leader together with their signatures. See Annex A1.2 for an example of an IRS house spray card.

Routine reporting forms

Standard reporting forms should be used by spray operators, team leaders and district coordinators to report, supervise and monitor IRS operations. Daily reporting forms are submitted at the end of the day to the spray team leader who records and checks the performance of his/her 6–10 spray operators. A weekly summary record is maintained by IRS subdistrict coordinators who track 2–5 spray teams and measure their weekly progress in relation to the total planned targets for the spray rounds. The district coordinators prepare monthly reports on their district's spray operations. See Annex A1.8, A1.9 and A1.10 for sample forms.

The daily spray operator's reporting form should contain:

- name and ID number of the spray operator and team leader
- location identification, family name, address, geo-code
- number of residents
- number of mosquito nets available
- number of rooms/units sprayed and unsprayed
- if unsprayed, for what reason (e.g. locked or refused)
- name of insecticide used
- number of charges/sachets used
- number of sachets returned empty.

The team leader's daily summary spray reporting form should contain:

- team leader's name and ID number
- names and ID numbers of the spray operators in his/her team
- total number of houses sprayed and unsprayed by each spray operator
- number of residents in the houses sprayed
- total number of houses with mosquito nets available
- total number of rooms/units sprayed and unsprayed
- total amount of insecticide used by the spray operators
- total number of charges/sachets used by the spray operators
- total number of sachets returned empty by the spray operators.

The district coordinator's monthly spray reporting form should contain:

- district coordinator's name and ID number
- total number of spray operators and team leaders in the district

- total number of houses sprayed and unsprayed in the district
- total number of people in sprayed and unsprayed houses in the district
- total number of houses with mosquito nets available
- total number of rooms/units sprayed and unsprayed in the district
- total amount of insecticide used in the district
- total number of charges/sachets used in the district
- total number of sachets returned empty in the district.

2.7.4 Evaluation of coverage, quality and impact

IRS household survey

District coordinators should conduct household surveys as part of their evaluation of operational coverage at the end of the spray round. These household surveys, when compared with the routine reports of the spray campaign, provide a figure for the actual coverage. These surveys can also be conducted as 'representative' sample surveys and combined with periodic malaria indicator surveys and other health surveys, and with other broader demographic surveys such as demographic health surveys (DHSs) or multiple indicator cluster surveys, as long as all samples are drawn from areas that were targeted for IRS.

Entomological performance indicators

Entomological monitoring is a key component of IRS programmes providing essential information on the presence of vectors, insecticide susceptibility status, quality of the spraying, and the impact of IRS on the vector population.

Vector dynamics

Vector species

It is essential to know which vector species are present in the target area. Mosquitoes can be sampled from at least one or two sentinel sites per district. Full-time entomological technicians and mosquito collectors or field workers should make collections prior to the beginning of spraying and, if possible, on a monthly basis during the transmission season. These collections will provide a measure of the impact of the intervention on the vector.

All mosquito specimens should be separated by location and identified using standard morphological keys. When sibling species are present, for example both *An arabiensis* and *An gambiae s.s.*, approximately 10% of female anophelines collected should be separated in numbered vials with silica gel desiccant. These should be sent to national or regional entomological reference laboratories for polymerase chain reaction (PCR) processing to confirm morphological identification. Captures resulting in small numbers (fewer than 20 individuals) should be sent in total for confirmation. Note that when conducting susceptibility tests, all specimens must be identified to the species level and not just to the species complex level (i.e. *senso lato*).

Vector density

Many methods exist for sampling mosquito populations to determine adult density. These include indoor knockdown collections using pyrethrum sprays, and direct collection from baited traps, light traps and exit traps. Collectors should take into consideration the specific inherent biases for each collection method. The concurrent use of several different collection methods may overcome some of these biases and allow sampling of populations to result in collections of vectors that have different behavioural characteristics and occupy different habitats.

Vector resting

Knockdown collections using pyrethrum-spray sheet methods and aspirator collections of mosquitoes are useful for sampling indoor-resting mosquito species during daytime hours. Some mosquitoes may leave houses after feeding or be forced out of houses during the night by the irritant effects of some insecticides or by smoke from cooking. These mosquitoes can be trapped as they leave the houses via exit window traps. Such collections provide information about indoor-resting behaviour and may help measure the effectiveness of IRS.

Human–vector contact

Human–vector contact can be measured directly through human landing collections (HLC) or indirectly, by determining the human blood index (HBI) from a representative sample of adult resting mosquitoes.

Vector survivorship

Mosquito survivorship can be estimated through dissection of the ovaries, and in one technique calculating the parity rate through the presence of uncoiled tracheolar skeins in the ovary or the presence of an ovariole sac or dilation.

Sporozoite rate

The detection of sporozoites of human origin in mosquito salivary glands is important in determining vector status. This is determined either through salivary gland dissection or the ELISA CS test. The sporozoite rate can be used to estimate the entomological inoculation rate described below.

Entomological inoculation rate

The entomological inoculation rate (EIR) is the product of the sporozoite rate and the human-biting rate and is an important estimate of transmission pressure. In areas where there are several vector species and large differences in biting rates and human blood indices between villages, the EIR is the most appropriate way in which to establish the relationship between the entomological and parasitological variables. The EIR can be used to determine the entomological impact of an intervention.

Wall bioassays

The quality of IRS applications, insecticide dosage and persistence on treated surfaces is qualitatively measured by WHO cone bioassay using susceptible strains maintained in a central laboratory. The WHO cone bioassay test (distinct from susceptibility test) checks the effectiveness of residual insecticide deposits over time, following spraying, and helps determine subsequent spray rounds and schedules. Bioassays of sprayed surfaces are also a means of monitoring the efficacy of spray operations. The cones are kept on the sprayed surface with mosquitoes for 30 minutes and the 24-hour mortality of the mosquitoes is recorded during this period. Tests should be conducted on 5–10 homes per week using three cones per home.

More robust quantitative insecticide test kits are under development to measure the amount of insecticide present on the treated walls. These use colorimetric assays to determine the amount of insecticide on the wall surface, and do not require a susceptible strain of live mosquitoes.

Insecticide resistance

As detailed in the GPIRM, resistance monitoring and management is an integral part of every IRS operation.

Test procedures and materials are available from WHO. It must be noted that detection of insecticide resistance does not automatically equate with control failure, but that preventive action should be implemented immediately.

Epidemiological performance indicators

Monitoring the epidemiological impact of an IRS programme may be complicated by inadequate diagnostic and reporting systems, the impact of concurrent interventions such as LLINs and improved diagnostics and treatment, or variability due to population movement or weather-related changes in the mosquito population. Nevertheless, programmes should endeavour to collect information on malaria trends in the community as they relate to the IRS implementation

First of all, epidemiological data should be based on parasitologically confirmed cases, and not on the highly inaccurate “fever” cases or clinically diagnosed “malaria”.

There are two basic sources of epidemiological information: facility-based parasite incidence data; and cross-sectional PP and anaemia data gained through population-based surveys. Each has its strengths and weaknesses.

Facility-based parasite incidence data is central to the WHO *T3 Initiative: Test, Treat and Track* (21). Malaria-endemic countries should ensure that every suspected malaria case is tested, that every confirmed case is treated with a quality-assured antimalarial, and that the disease is tracked through timely and accurate surveillance systems to guide policy and operational decisions. The initiative is built upon the 2012 revised *Disease surveillance for malaria control: an operational manual* (1). Details on the tools, procedures, people and structures needed to build an effective epidemiological surveillance system during the control phase are provided in this manual.

While surveillance data are subject to incomplete reporting and bias, this source of information has the advantage of continuous collection from every district in a country; for most districts, such data are the only readily available source of information on malaria that can be used by programme managers. When surveillance systems are working well, they show consistent seasonal variation in the numbers of cases, coinciding with the pattern of malaria transmission. They also show reductions in morbidity and mortality in response to interventions and can alert managers to unexpected increases. Thus, although results should be interpreted with care, they are a critical source of information for programme management and should not be ignored. Continued efforts to improve reporting systems and use of these data will help to improve the quality of malaria surveillance and the operation of national malaria control programmes.

A second source of epidemiological information is through periodic cross-sectional household surveys that may include an indicator for anaemia as well as PP. If conducted, such malaria indicator surveys should be carried out at the peak of the transmission period and conducted in the same month in subsequent years. Population-based malaria indicator surveys can be expensive and must be planned with care to yield useful results (22).

Social performance indicators

When resources allow, the attitude of the community towards IRS can be assessed through community knowledge, attitude, behaviour and practice surveys. Such surveys are not required to run an IRS programme, and should be reserved for situations where there appears to be a community-related problem with an IRS programme. The information to be collected during routine spraying may include community acceptance, or reasons for not accepting the spraying, locking rooms or re-plastering sprayed rooms. This information can also be collected as part of malaria and other household surveys and can help guide the development of educational messages to improve programme performance.

2.8 Review of annual operations

2.8.1 IRS programme operational review

IRS operational reviews should be undertaken at the end of each spray round to determine whether all aspects of the operation have been carried out according to the POA.

There should also be a more comprehensive annual meeting held 1–2 months after the spray round has been completed to review the overall IRS operation, to ensure programme targets and objectives have been achieved, and to outline adjustments and improvements for the next year's operation. Reports and presentations should be prepared by districts and provincial IRS coordinators. The national IRS coordinators and IRS vector-control committee members should review the performance of provinces and districts and provide feedback.

Annual IRS reports should be prepared at all levels by IRS coordinators at the end of the spray cycle.

The following areas should be reported on.

- *Coverage*: the percentage of total number of structures sprayed in relation to overall target structures; the refusal rate, the reasons for refusal and how to address this in the future.
- *Timing*: was the insecticide applied at the appropriate time in relation to the onset of malaria transmission?
- *Equipment*: the performance of the spraying equipment under operational conditions.
- *Expenses*: resource utilization (salaries, per diems, spray equipment, insecticides, transport costs).

These reports will provide valuable information for the planning and budgeting of future IRS interventions.

2.8.2 IRS programme strategic review

Following any IRS programme an evaluation of outcomes and impact (from routine health systems data) should be produced. This should document results in terms of improved quality of delivery and coverage targets and changes in malaria incidence or prevalence. This will also establish the need for training and research activities.

Periodic programme evaluations bring together all operational information collected as a basis for planning, and allow assessment of the broader programme components such as cost, policy, management structure and organization, effectiveness and efficiency of the intervention, and the programme's performance and sustainability. These evaluations should ideally be carried out after the completion of 2–4 spray rounds; they will help to identify trends, and strengths and weaknesses that could be instrumental in making decisions about future expansion of interventions or reduction of target areas and objectives.

Operational research provides answers to questions tied to specific situations or problems that may require more rigorous examination than the straightforward tracking of indicators. Research priorities should be developed based on the operational challenges faced during the implementation of the IRS programme (i.e. changes in vector composition and behaviour, and changes in programme organization and structure).

2.9 References and web links

1. World Health Organization. Disease surveillance for malaria control: an operational manual. Geneva, 2012; World Health Organization. Disease surveillance for malaria elimination: an operational manual. Geneva, 2012
(<http://www.who.int/malaria/areas/surveillance/operationalmanuals/en/>, accessed 3 January 2013).
2. World Health Organization. WHO test procedures for insecticide resistance monitoring in malaria vector mosquitoes, Geneva, 2013
(<http://www.who.int/malaria/publications/atoz/9789241505154/en/>, accessed 5 May 2015).
3. Details and procedures for entomological field techniques are available in: World Health Organization. Manual on practical entomology in malaria. Part 1 – Vector bionomics and organization of anti-malaria activities; Part II – Methods and techniques. Geneva, 1975
([http://whqlibdoc.who.int/offset/WHO_OFFSET_13_\(part1\).pdf](http://whqlibdoc.who.int/offset/WHO_OFFSET_13_(part1).pdf), and [http://whqlibdoc.who.int/offset/WHO_OFFSET_13_\(part2\).pdf](http://whqlibdoc.who.int/offset/WHO_OFFSET_13_(part2).pdf), accessed 10 January 2013).
4. World Health Organization. Malaria elimination: a field manual for low and moderate endemic countries. Geneva, 2007
(<http://www.who.int/malaria/publications/atoz/9789241596084/en/index.html>, accessed 3 January 2013).
5. Details and procedures are available in: World Health Organization. Geographical reconnaissance for malaria eradication programmes. Geneva, 1965
(http://whqlibdoc.who.int/hq/1965/PA_264.65_eng.pdf, accessed 10 January 2013); and in the more recent publication: World Health Organization. Malaria elimination: a field manual for low and moderate endemic countries. Geneva, 2007
(<http://www.who.int/malaria/publications/atoz/9789241596084/en/index.html>, accessed 3 January 2013).
6. World Health Organization. Global Plan for Insecticide Resistance Management in malaria vectors (GPIRM). Geneva, 2012
(http://www.who.int/malaria/vector_control/ivm/gpirm/en/index.html, accessed 3 January 2013).
7. World Health Organization. International programme on chemical safety. Environmental health criteria 241. DDT in indoor residual spraying: human health aspects. Geneva, 2011.
8. World Health Organization. The use of DDT in malaria vector control: WHO position statement on DDT. Geneva, 2011
(http://www.who.int/malaria/publications/atoz/who_htm_gmp_2011/en/index.html, accessed 8 January 2013).
9. World Health Organization. International code of conduct on the distribution and use of pesticides: guidelines for the registration of pesticides. Geneva, 2010
(<http://www.who.int/whopes/en/>, accessed 8 January 2013).
10. Technical guidance for management of public health pesticides: policy frameworks and guidelines are available on the WHO Pesticide Evaluation Scheme (WHOPES) website at http://www.who.int/whopes/recommendations/who_fao_guidelines/en/index.html (accessed 8 January 2013).
See also: World Health Organization. Guidelines for procuring public health pesticides. Geneva, 2012
(http://whqlibdoc.who.int/publications/2012/9789241503426_eng.pdf, accessed 8 January 2012).

11. Roll Back Malaria (RBM). Procurement: insecticides and spraying equipment for indoor residual spraying. See various documents at http://www.rollbackmalaria.org/microsites/archive/newsletters_2006_2015/procurementirs.html (accessed 13 May 2015).
12. Food and Agriculture Organization of the United Nations. Pesticide storage and stock control manual. Rome, 1995
(<http://www.fao.org/docrep/V8966E/V8966Eoo.htm#2>, accessed 8 January 2013).
13. World Health Organization. Safe use of pesticides. Third report of the WHO Expert Committee on Vector Biology and Control. Geneva, 1979. WHO technical report series, 634: 17–18
(http://whqlibdoc.who.int/trs/WHO_TRS_634.pdf, accessed 8 January 2013).
14. Reigart JR, Roberts JR. Recognition and management of pesticide poisoning, Fifth edition. Washington, United States Environmental Protection Agency, 1999
(<http://www.epa.gov/oppfead1/safety/healthcare/handbook/Front.pdf>, accessed 8 January 2013).
15. World Health Organization, and Food and Agriculture Organization of the United Nations. International code of conduct on the distribution and use of pesticides: guidelines on management options for empty pesticide containers. Geneva, 2008
(http://www.who.int/whopes/recommendations/Management_options_empty_pesticide_containers.pdf, accessed 8 January 2013).
16. World Health Organization. Test procedures for insecticide resistance monitoring in malaria vectors, bio-efficacy and persistence of insecticides on treated surfaces. Report of the WHO Informal Consultation. Geneva, 1998
(http://www.who.int/malaria/publications/atoz/who_cds_cpc_mal_98_12/en/, accessed 8 January 2013).
17. World Health Organization. Equipment for vector control – specification guidelines. Revised version. Geneva, 2010
(<http://www.who.int/whopes/equipment/en/>, accessed 8 January 2013).
18. Rozendaal JA. Vector control: methods for use by individuals and communities. Chapter 9. Geneva, World Health Organization, 1997
(<http://www.who.int/malaria/publications/atoz/9241544945/en/index.html>, accessed 10 January 2013).
19. Adapted from Lluberas, M. Code of conduct for spray team members. American Mosquito Control Association, Wing Beats Magazine, Summer 2012: 25–27
(<https://amca.memberclicks.net>, accessed 18 January 2013).
20. President’s Malaria Initiative BMP manual. Best management practices (BMP) for indoor residual spraying in vector control interventions. Updated July 2010
(http://www.pmi.gov/docs/default-source/default-document-library/tools-curricula/bmp_manual_aug10.pdf?sfvrsn=4, accessed 30 January 2015).
21. World Health Organization. T3: Test. Treat. Track. Scaling up diagnostic testing, treatment and surveillance for malaria. Geneva, 2012
http://www.who.int/malaria/publications/atoz/t3_brochure/en/, accessed 13 May 2015).
22. World Health Organization. Malaria indicator survey: basic documentation for survey design and implementation. Roll back malaria monitoring and evaluation reference group. Geneva, 2005
(<http://www.who.int/malaria/publications/atoz/9241593571/en/index.html>, accessed 10 January 2013).

CHAPTER 3

Conducting a house spray



Contents

3.1	Conducting a house spray	69
3.1.1	Communicating with the villages and households	69
3.1.2	Preparing rooms and households	70
3.1.3	Preparing the spray charge	70
3.1.4	Applying insecticide	74
3.1.5	Insecticide spray procedure	74
3.1.6	Spray data recording and reporting	78
3.1.7	Post-spraying procedures	79
3.2	Spray equipment inventory and maintenance	79
3.2.1	Inventory	79
3.2.2	Calibrating the sprayer nozzle	80
3.2.3	Maintenance and cleaning of the sprayer	80
3.2.4	Troubleshooting on the hand-compression sprayers	81
3.2.5	Spare parts and maintenance tools	82
3.2.6	Spray equipment transport and storage	82
3.3	Human safety and environmental protection	82
3.3.1	Occupational safety	82
3.3.2	Insecticide poisoning and first-aid measures	83
3.3.3	Treatment of insecticide side-effects	84
3.3.4	Recycling and waste management	84
3.4	Spray application supervision	85
3.4.1	Purpose of supervision	85
3.4.2	Supervisory tools	85
3.5	Important health and environmental safeguards necessary for IRS operations	86
3.6	References and web links	86

3.1 Conducting a house spray

Once the necessary planning, procurement and training has been completed in preparation for IRS, actual house spraying can begin. This phase of the IRS operations involves informing the community so that they may be ready for the spray teams when they arrive (moving household items, making water for mixing available); preparing insecticides; spraying target structures; and recording which structures are sprayed and which are not. Adequate supervision is important to ensure each step is performed efficiently and to the highest standards.

3.1.1 Communicating with the villages and households

Prior to spraying, team leaders must contact community leaders to inform them of the planned spray operations and of the fact that IRS team members will be visiting the villages to provide more detailed information and to conduct the spray. The day before the actual spraying (or as near to the planned spraying date as possible), a member of the IRS team, known as the ‘warner’ or ‘sensitizer’, travels to the target location and informs community leaders and householders of the purpose of spraying, the details of the spraying schedule, and what residents are expected to do in preparation. In this way, members of the community understand what they need to do to facilitate the operations and can prepare their homes and other structures in advance of the spraying. The information provided must be as simple as possible and the use of technical words must be minimized.

Spray operators should always maintain a positive approach when communicating with village leaders and householders. As observed in the code of conduct (1) (see Annex A1.6), the spray teams are “the face” of the national malaria control programme and of the ministry of health and, as such they have a duty to always act in a professional manner and to maintain good relations with the villagers.

On the day of spraying itself, it is important that the spray operators reinforce to householders the objectives of the IRS programme and outline to them the benefits, safety precautions and potential post-spraying side-effects. The residents should be given information on how long the insecticide is expected to remain effective on their walls, and about the importance of not replastering, painting or washing the walls during that period, and should be instructed to continue using treated mosquito nets if these are available. They should also be reminded of the importance of waiting outside after spraying is complete, until the insecticide is dry, to reduce the risk of skin and eye irritations. This usually takes about 1 hour. In some circumstances where there is high humidity, drying may be delayed and householders may be requested to remain outside longer, up to 2 hours.

The spray operators should also reassure the occupants of the effectiveness and safety of the insecticide being used and tell them where to seek advice and assistance if they experience any problems with side-effects; reassure residents and community leaders that the insecticides applied will not damage walls, ceilings and furniture; and reassure householders that operators will not spray places used for storage of foods such as rice, yams or corn.

Specifically, spray operators should ensure that householders willingly agree to:

- allow spray teams to enter their households;
- collect and make available at least 15 litres of clean water for mixing of insecticides in the sprayer and for any other use;
- notify the spray team if there are sick residents, newborn infants, or any cultural issues that would prevent a room or house from being sprayed;
- prepare houses for spraying by covering or moving portable items outside (e.g. foodstuffs and other consumables, cooking utensils, light furniture, bedding and clothing);

- move those items that cannot be taken out of the dwelling to the centre of the room and cover them with a plastic sheet;
- move themselves and their families outside and remain outside for an hour or more while the insecticide dries;
- sweep out any household pests (e.g. cockroaches, beetles) that are killed in the house by the spraying and bury, burn, or dispose of these in a pit latrine;
- prevent chickens and other domestic fowls from eating the dead insects; and
- refrain from re-plastering, painting or washing the sprayed surfaces for at least 6 months. This is important in order to allow the residual effect of the insecticide to continue killing mosquitoes.

3.1.2 Preparing rooms and households

To prepare for spraying, householders must remove as many of their household contents as possible, especially water containers, food, cooking utensils and toys. All pictures, wall hangings and posters should be removed. Items that cannot be removed should be completely covered with plastic sheeting and placed in the centre of the room to allow easy access to the walls. Caged or leashed pets and domestic animals should be relocated away from the house until sprayed surfaces have dried and dead insects have been swept up and removed from the floor.

3.1.3 Preparing the spray charge

Just as there are a series of steps for the householder to prepare the structures for spraying, there is a standard series of procedures for the spray operator to prepare the insecticide mixture (the “charge”) to spray. The following nine steps should be followed to ensure safe and proper application.

Step 1: Wearing protective clothing and gear

The first step is for the spray operator to put on protective clothing and gear. Spray operators must be aware that they are at occupational risk when using insecticides. It is their responsibility to ensure they use the following protective clothing:

- broad rim hat or plastic helmet (to protect head, face and neck from spray droplets);
- full face shield or goggles (to protect eyes against spray fall-out and splashes);
- face mask/respirator (to protect nose and mouth from airborne particles of the spray fall-out and to avoid inhalation);
- long-sleeved overalls;
- mutton cloth or light cloaks (to protect the neck)
- rubber gloves (to protect the hands);
- boots (to protect the feet); and
- raincoat (to protect spray operator when it is raining; not to be used during spraying).

The spray operator should also check other support items including:

- notebook and records
- bag/satchel for carrying charges

FIG. 8
Relocating animals before spraying

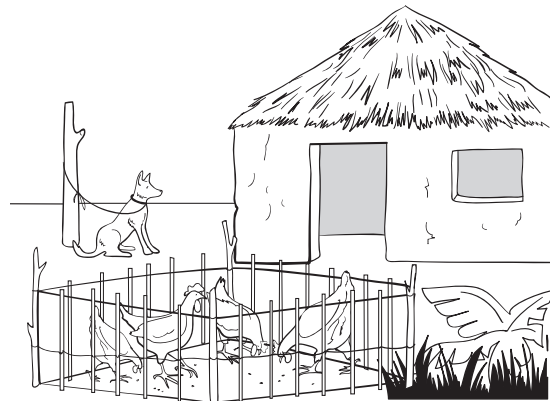

Source: WHO

- muslin cloth or metal strainer for sieving dirty water
- plastic sheeting.

Step 2: Checking the sprayer

Before starting a spray operation, the equipment must be checked. Faulty sprayers may result in poor application, over or under-application, and personal or environmental contamination.

Examine the sprayer to ensure that all component parts are present, assembled correctly and in good condition.

- sprayer tank
- shoulder strap
- inner seal lid
- pump (handle)
- pressure gauge
- lance
- in-line strainer (is the strainer inside the valve handle clean?)
- hose
- nozzle assembly with a CFV fitted to the nozzle tip
- trigger on/off valve (cut-off valve)
- footrest
- trigger assembly
- shut-off valve (open) if one is present.

Note: Note: Check that the correct type of nozzle (flat fan nozzle with 80° swath and 0.55 L/min flow rate at 1.5 bar pressure) is fitted and is not damaged or worn.

Note: The sprayer should be fitted with a CFV, this is a standard for compression sprayers used for IRS (5). The recommended valve operates at 1.5 bar and gives a constant output at the nozzle until the tank pressure is below the stated pressure of the CFV. Spraying will then stop, indicating that the operator must re-pressurize the tank.

The CFV must be fitted between the tank outlet and the nozzle. Usually, it is fitted next to the nozzle (Fig. 10).

- Fit the valve by first removing the nozzle tip and cap. Fit a washer, if not present, into the end of the CFV that is screwed to the end of the lance. Then, with another washer if necessary, screw back the nozzle body, tip and cap onto the CFV.
- Alternatively, for other lances, fit the valve by first removing the nozzle body. Fit a washer, if not present, into the end of the CFV that is screwed to the end of the lance. Then, with another washer if necessary, screw back the nozzle body, tip and cap onto the CFV

FIG. 9
Sprayer assembly to meet WHO specifications

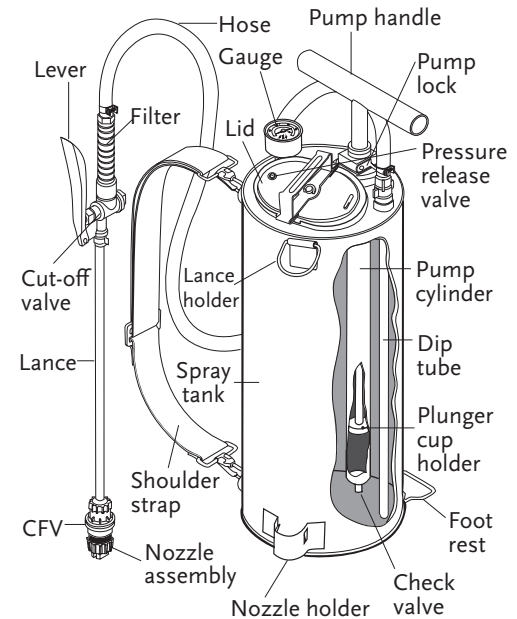

Source: WHO

FIG. 10
Control flow valve (CFV)

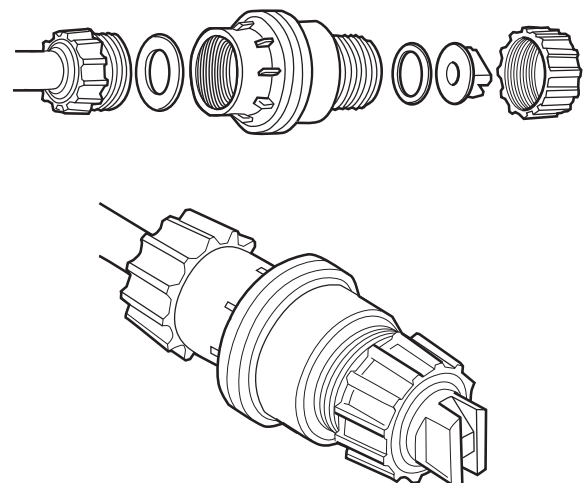

Source: WHOPES

Step 3: Mixing the insecticide

Spray operators must follow the instructions on the product label to ensure safe and correct mixing, handling and application of insecticides. The insecticides should be mixed outdoors or in a well-ventilated area.

While in the field, keep the insecticide sachets or containers in the sachet holders or in drums or cartons free from moisture, heat and direct sunlight.

In order to mix the product, the following items are required:

- product pre-measured and factory-packed in sachets or plastic bottles (one chemical charge for filling one spray pump);
- functioning sprayer;
- appropriate protective clothing; and
- bucket with clean water.

If the standard spraying procedure is adopted, the spray liquid will be applied at a rate of *30 ml per m² or 1 litre per 33.3 m²*. This amount of suspension normally stays on the surface without run-off.

In general, insecticides now come in pre-measured sachets for ease of use.

Step 4: Preparing the sprayer

- *To close tank*: insert the cover vertically into the tank, lift it and fit it into the tank opening; turn the handle across the width of the opening.
- *To open tank*: push down the air-release valve by turning the handle on the cover; the cover will become loose once the air pressure is released and the tank reaches atmospheric pressure.

Step 5: Filling the spray tank

For sprayers without a 1.5 bar CFV

Spray operators should identify a suitable flat, level and hard surface on which to place the sprayer and half-fill the tank with clean water. A sachet or bottle of IRS formulation enough to spray an area of 250 m² will require a 10 litre tank mix for a compression sprayer **not fitted** with 1.5 bar CFV discharging at rate between 760 and 790 ml per minute. The pre-packed insecticide from sachets or plastic containers should be added directly into the spray tank, the sprayer lid should be closed tightly and the contents mixed by agitating the sprayer. The tank must then be filled with the required total amount of water. The tank usually has a mark indicating the total water level and for most standard sprayers this is 10 litres.

For sprayers with a 1.5 bar CFV

A sachet or bottle of IRS formulation enough to spray an area of 250 m² will require a 7.5 litre tank mix for a compression sprayer fitted with a 1.5 bar CFV discharging at a rate of 550 ml per minute. When using a 1.5 bar pressure (1.5 bar CFV), measure 7.5 litres of water. The first 4 litres of this water should be added to the tank and the contents of the sachet should be added to this. The remaining 3.5 litres of water should then be added to the mixture. The lid should then be replaced and the tank slightly pressurized. The tank can then be shaken to mix the insecticide well, following which the sprayer can be fully pressurized to 4 bar to commence spraying.

Step 6: Shaking the spray tank

The suspension needs to be well mixed by shaking the tank before beginning to spray and by shaking again at regular intervals during spraying. Shaking is done by grasping the sprayer by the pump shaft and the bottom end of the tank. The tank should not be held by the strap, nor should it be swung forwards and backwards while on the shoulder. Formulations that meet WHOPES specifications should remain in suspension with minimum shaking.

Step 7: Pressurizing the tank

Sprayer without a 1.5 bar CFV

Spray operators in programmes still using pumps not fitted with a 1.5 bar CFV should take the following steps to pressurize the tank:

- use the pressure gauge (manometer) to monitor the pressure in the compression sprayer;
- put one foot on the footrest and unlock the pump plunger. Pull the plunger all the way up with both hands and then push it downwards using full, even strokes;
- pump strokes should be even and regular from top to bottom (short irregular strokes make more work and less pressure input per stroke);
- keep pumping the sprayer until it registers a pressure of about 4 bar which is 58 psi. The upper and lower operating pressure limits are 400 kPa (58 psi) and 172 kPa (25 psi), giving an average pressure during spraying of about 276 kPa (40 psi);
- while some sprayers have not yet been fitted with CFVs, it is important that operators of these sprayers re-pressurize to keep the pressure between 25 and 58 psi throughout the entire charge. As the water level decreases in the sprayer, more strokes will be required to return it to its required pressure;
- if the pressure is too high, the flow rate will be too high and cause run-off from the wall, which may increase spray bounce off and contribute to early damage of the nozzle aperture;
- if the pressure is too low, the spray angle will be too small and the operator may try to compensate by reducing the distance of the nozzle from the wall thereby altering swath width and the spray deposit on the wall;
- check the pressure by looking at the pressure gauge (manometer), which usually shows the 'operational pressure range' by a colour band. Pressure should not be checked by:
 - the amount of fluid discharged
 - the appearance or width of fan shaped spray
 - the time of last pumping;
- always release pressure when sprayer is not in use, for example:
 - when the operator stops for long breaks (e.g. for lunch)
 - when the sprayer is being transported.

It will usually be necessary to re-pressurize and re-shake the sprayer once or twice before it is empty.

Sprayer with 1.5 bar CFV

For sprayers operating at 1.5 bar: when the tank pressure has decreased to below 1.5 bar, the CFV will close and the tank should be re-pressurized to use the remaining spray. Note, it may not be necessary to pump to 4 bar (58 psi) if there is a small amount of spray left in the tank. Note also that to spray 7.5 litres at 550 ml/min usually takes 13.6 minutes.

Step 8: Checking the nozzle

Spray operators should inspect the nozzle daily for blockages or signs of wear. Blockages can be removed by cleaning with water or by using a soft probe such as a brush or grass stalk. Sharp instruments should be avoided and operators should NEVER put the nozzle between the lips and blow.

Step 9: Carrying and handling the sprayer

- *Carrying position when not spraying:* the sprayer should be placed on the back of the left shoulder in an upright position with the strap in front and the hose collected under the sprayer lid handle.

- *Carrying position when spraying:* the sprayer should be placed on the front, hanging under the left shoulder with the upper part of the sprayer forward. The sprayer is held with the left hand on top. The pressure gauge does not need to be monitored regularly because a pump fitted with a 1.5 bar CFV will continue to operate and only stop when pressure falls below 1.5 bar. This position allows for:
 - quick unloading for placing on the ground for re-pressurizing
 - easy handling in narrow passages and rooms.

Spray operators should always check and adjust the strap for comfortable carrying and handling.

3.1.4 Applying insecticide

The insecticide suspension has to be sprayed evenly and at the recommended application rate over all sprayable surfaces. The amount of insecticide that is sprayed on a surface is determined by a number of different factors.

Factors that are influenced by the spray operator during the spraying, and that need to be highlighted during training are:

- distance from the nozzle tip to the surface being sprayed (should be kept at 45cm);
- speed of movement of the nozzle over the surface; and
- air pressure in the sprayer (should be maintained at 172–380kPa (25–55psi) or (1.7–3.8 bar) for a sprayer without a 1.5 bar CFV.

Air pressure in the sprayer with a 1.5 bar CFV should initially be 4 bar. When the spray stops and tank pressure has fallen to 1.5 bar, the air pressure should be increased by further pumping until the tank pressure rises to above 2 bar (29 psi) while spraying. With a 1.5 bar CFV, spray is applied at a constant flow rate at 1.5 bar pressure at the nozzle.

Factors that are not directly influenced by the spray operator, but that require attention during preparation for actual spraying are:

- the concentration of insecticide in the suspension
- the nozzle tip aperture size.

3.1.5 Insecticide spray procedure

The quality of spraying affects the residual effectiveness of the insecticides.

General: In households with multiple rooms, spraying should commence in the innermost rooms and work outwards.

Total coverage: Spray teams and spray operators must find and spray every single sprayable structure in the target area.

Complete spraying: All sprayable surfaces within a structure must be sprayed and no sprayable areas should be left out, missed or forgotten. Sprayable structures include all buildings, large or small, in which people may sleep or gather at night.

Sprayable structures: These include houses, kitchens, health centres (with overnight patients), hospitals, hotels and rest houses, fishing huts, and huts in the field. Animal shelters (cattle sheds in some countries) with roofs can be sprayed but open pens and corrals should not be sprayed.

Schools, shop houses, churches, health centres and other buildings should not be sprayed unless people regularly sleep in them overnight. Latrines are generally not sprayed. The underside of tin/metal roofing should not be sprayed as these can reach high temperatures during the day, which may significantly reduce the duration of effectiveness of the insecticide. However, the undersides of thatch roofing may be sprayed.

Sprayable surfaces: These are all inside walls, the insides of roofs and under eaves, under exposed doors, verandas, rafters and beams. Sprayable surfaces also include the undersides of beds, tables, chairs, shelves, and the backs of cupboards and wardrobes.

Correct dosage: The right amount of insecticide should be deposited on the targeted spray surfaces. The following 10 steps should be followed by spray operators to ensure good practice during spraying:

Step 1: Inspecting the room

To inspect the room:

- on arrival, greet the householders and explain the purpose of the visit;
- request permission to enter the rooms, being led by a member of the family;
- enter the room and conduct a general inspection;
- ensure that the room has been cleared or heavy furniture has been moved to the centre of the room and covered with plastic sheeting;
- check that wall hangings and other items on walls have been removed;
- if the structure has more than one room, make sure that there is no one in the other rooms; and
- check that all food and water containers have been removed.

Step 2: Carrying the sprayer correctly

Once the inspection is finished:

- lift sprayer using the shoulder strap;
- position strap on the shoulder and tank under the armpit so that the pressure gauge is visible;
- adjust shoulder strap to appropriate length;
- support the hose and lance in one hand; and
- enter the room to be sprayed and face the door.

Step 3: Maintaining correct distance and angle for spray pattern or swath

Keeping the correct distance and angle of spraying is critical in depositing the correct concentration of insecticide on the sprayed surfaces. Spray operators should:

- stand in front of the spray surface area;
- maintain a body position of an average of 1 m from the surface to be sprayed;
- maintain a distance of 45cm (or 1.5 feet) between the spray nozzle and surface to be sprayed (see Fig. 11). This provides a spray pattern of swath which covers 75 cm;
- be aware that due to reduced deposit at the edges of the spray pattern, a 5cm overlap needs to be maintained in order to achieve an even coverage of adjacent spray patterns of swaths;
- always begin spraying at the top of the swath, moving down and then up and from the left hand side towards the right hand side of the area to be sprayed;
- maintain a smooth comfortable action with the hand and elbow. The arm should be extended

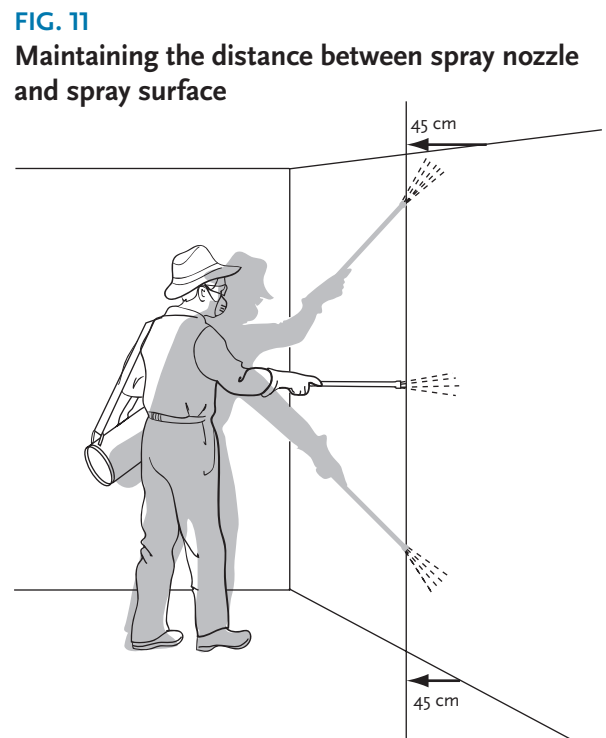

Source: WHOPES

fully at the top and bottom with elbow bent in the middle to maintain a 45 cm distance from the nozzle to wall; and

- ensure that:
 - in the upper position the spray pump lance moves vertically upwards;
 - in the middle position the spray lance remains horizontal; and
 - in the lower position the spray lance moves downwards vertically through the middle position.

The first swath is from top to bottom. After the first swath, the spray operator should take a step sideways to get to the middle of the next swath and cover the second swath from bottom to top. The correct footwork should be maintained together with the hand spray speed to generate the correct rhythm.

The correct timing for spraying a 2 m swath is 5 seconds (i.e. each linear metre covered should take 2.2 seconds). Timing may be aided by mentally counting “one thousand and one, one thousand and two, one thousand and three”, etc. Adjust the mental counting procedure according to the local language.

To maintain the proper distance between the nozzle and the sprayed surface while spraying vertically (i.e. a wall or the back surface of large furniture), it is necessary to slowly bend the elbow towards the waist as the nozzle approaches the midpoint. At this point, the elbow should be bent at a 90° angle. The arms must be extended as the spraying progresses. This process must be followed throughout the entire spraying process.

A uniform speed of spraying is required to provide the correct target dosage.

If the arm moves too quickly, less spray will be applied, with the result that the amount of insecticide deposited will be lower than the recommended concentration. This will reduce insecticidal activity and greatly impact on the efficacy of the operation. It might also contribute to the emergence of vector resistance if inadequate concentrations are repeatedly applied. On the other hand, if the spray speed is too slow there will be an overdose of insecticide, resulting in wastage and unnecessary extra costs.

Step 4: Spraying doors and windows

Total coverage cannot be achieved without spraying the sides of all doors and windows of the targeted structures. In particular:

- when doors and windows open inwards, both sides need to be sprayed;
- when doors open outwards, only the interior surface needs to be sprayed;
- the doorframe must be sprayed, beginning from the left or right bottom corner;
- the portion of the wall covered by the door (behind the door) must be sprayed; and
- once sprayed, the door should be opened to allow adequate lighting into the room for the rest of the spray operation.

Step 5: Spraying the wall (vertical spraying)

Starting from the edge of the doorframe, spray operators should spray the walls as described above moving in a clockwise direction (Fig. 11). Spray operators must:

- make sure the overall swath is 75 cm if the nozzle is 45 cm from the wall;
- maintain an overlap of 5 cm for successive swaths;
- maintain the rhythm of no more than 5 seconds for every 2 vertical metres;
- agitate the sprayer at regular intervals while checking the pressure gauge; and
- ensure that pressure does not drop below 25 psi (172kPa) for sprayers without a 1.5 bar CFV (re-pressurization will be required below this level). One pump stroke generally adds 1 psi to the tank pressure.

Step 6: Spraying the ceiling

Spraying of inner roof and ceilings requires horizontal spraying. Spray operators should:

- spray the ceiling or underside of the roof after the walls have been sprayed;
- for distance and timing of spraying, follow the method outlined above for spraying of walls;
- use a lance extension tube where necessary;
- ensure pressure is at 58psi or 4 bar before spraying the roof (for those programmes still using compression sprayers without CFVs) or above 2 bar when using a sprayer fitted with 1.5 bar CFV;
- wear a hat when spraying the roof or ceiling, and use an extended lance if needed;
- stay in front of the spray swath (in front of the nozzle) to minimize exposure to insecticide that may drift down, each time maintaining a distance of 45cm from the surface;
- spray horizontally from the furthest point inside the room until arriving back at the start point;
- move up to the next swath and spray round the room;
- **avoid exposure to spray fall-out** by directing the lance at an angle from the body so that the spray not deposited on the roof does not fall on the operator and by walking backwards to the door;
- on completion, exit room and close the door; and
- spray door from outside.

In houses without a ceiling, the inside of the roof may be too high to spray with the standard lance provided with the sprayer. Such houses should be visited by two spray operators, one who is equipped with the standard lance and is responsible for spraying the walls, while the other has a sprayer on which the lance is fitted with an additional lance. The nozzle and CFV are unscrewed from the lance, the extra straight lance is screwed onto the lance and the nozzle and CFV screwed back onto the end of the lengthened lance. This allows spray to be applied with the nozzle at a greater height, so that the inside of a roof can be treated. A different type of nozzle should not be fitted.

Step 7: Spraying eaves and openings

The house eaves and areas around openings such as doors and windows need special attention. Spray operators should:

- start spraying the inside of the eaves, beginning from above the door from the outside
- move around the house spraying the outside eaves, taking care to avoid insecticide fall-out
- make sure that there is an overlap between the wall and the roof
- upon completion of the eaves, spray around the window openings and air vents.

Step 8: Spraying difficult-to-reach surfaces and other structures

It is important that insecticide coverage reaches all potential mosquito resting sites. Obstacles such as chairs, tables and cupboards against walls can impede progress and cause interruption of spray timing and pattern. It may be necessary for the spray operator to adopt different postures while maintaining basic distance and speed (e.g. bending knees to reach under beds).

The underside of floorboards of houses that are elevated or raised above the ground on stilts or posts provide ideal resting sites for many *Anopheles* vectors. These areas must also be sprayed; an extension lance may be necessary for tall houses. In the Asia-Pacific region, flexible swan neck extensions are necessary for spraying the underside of floorboards. These can be used to spray the edges. The swan neck can also be used in situations where it is difficult to spray (e.g. under the bed and where there are cupboards, furniture, floorboards).

After completing the spraying of the rooms, operators must spray the internal walls of other outside structures such as toilets (pit latrines) and bathrooms, poultry runs and animal sheds.

Poultry and animals should be taken out and secured outside for one day. The inside of granaries or any rooms where agricultural products are stored should NOT be sprayed.

Step 9: Post-spraying communication

Spray operators should give the following post-spraying information and education to householders:

- advise residents to stay outside until the sprayed walls and other surfaces have dried, which usually takes about 1 hour;
- advise residents that there is likely to be residual odour but this should not be cause for alarm;
- instruct residents to sweep the floor before allowing in children or pets, and to dispose of dead insects and other material immediately by burying or burning; and
- inform residents of any future spray plans involving their neighbourhood.

Step 10: House spray record keeping

Houses visited by spray teams and which have been totally sprayed can be marked with paint or chalk with the team number and date on the front wall. House spray cards can also be updated by writing the house number, spray operator number, team number and date. Locked houses, rooms and households whose residents have refused IRS should be marked with an R (e.g. 16 (R) T1, 21/04/12).

16 – spray operator number
(R) – refused
T1 – team number
dd/mm/yy – complete date.

Information such as locked rooms, refusals and the number of spray charge(s) used should also be recorded in the daily spray operator record form or book.

Houses and structures that have not been sprayed can be followed up with mop-up spraying if they are identified and recorded at the time of the initial attempt.

3.1.6 Spray data recording and reporting

The spray operator should ensure that household information is filled in accurately before leaving the site. This information must be presented to the team leader at the end of each working day using the daily reporting form. It is the responsibility of the team leader to summarize this information at the end of each working day. The information is necessary for programme management and supervision and it will be cross-checked with the information provided by district supervisors.

Malaria house spray cards

An IRS household record card is kept accessible in each household. The house spray card acts as a census record of the number of people and rooms or structures per household or dwelling and provides a record of insecticide spraying for each numbered house. Annex A1.2 shows an example of the card.

Routine reporting forms

Spray operators, spray team leaders and IRS district coordinators should use standard reporting forms to report, supervise and monitor IRS implementation. A daily reporting form (see Annex A1.8) is completed by the spray operator for each house and submitted at the end of the day to the spray team leader who records and checks the performance of the individual spray operators. A weekly reporting form (see Annex A1.9) should be maintained by IRS district supervisors and

districts IRS coordinators. Each coordinator tracks around 4–10 spray teams and measures the weekly progress in relation to the total planned target for the spray round. A monthly reporting form (see Annex A1.10) is used by IRS district coordinators to monitor progress on IRS spraying coverage for the spray round in the district in relation to the total planned target.

3.1.7 Post-spraying procedures

When spraying has finished for the day, and before removing any protective clothing, the following procedures should be followed:

- all the empty chemical containers/sachets should be returned and counted, and unused chemicals should be returned to the supervisor;
- the day's spray report should be submitted to the supervisor;
- any final surplus spray solution from the final cleaning through the progressive rinse method should not be thrown away but be kept and reused the next day;
- sprayers **must** be cleaned daily inside and out using the progressive rinse method of saving and recycling water used for cleaning the sprayers and reusing it the next day. The spray mixture should not be left in sprayers overnight as suspension will start caking and block the filters and hose. The chemicals may also damage the components of the sprayer and reduce their lifespan (e.g. seals or valves will stick and disintegrate);
- sprayers should be checked for any faults that may have developed and these should be reported to the team leader;
- all cleaning and washing of the sprayer should be done away from water sources;
- cleaned sprayers should be put in an inverted position to drain off any water; and
- sprayers should be returned to storage making sure they are kept dry. If possible, they should be stored in an inverted position with the cover assembly loose.

After doing all the above, spray operators should:

- remove protective clothing and gear;
- wash their whole body thoroughly using soap, paying particular attention to exposed areas such as hands and face;
- wash used protective clothing in detergent (separately from household washing); and
- dispose of washing water and rinse water safely, using a toilet or bathroom with a soak pit or soakway.

3.2 Spray equipment inventory and maintenance

3.2.1 Inventory

A monthly inventory of spray equipment should be maintained during the spraying period. The final inventory at the end of the spray round should indicate repairs and replacement needs. Sprayers and insecticides are expensive items: insecticide must be used economically and sprayers should be handled and maintained carefully. Developing and implementing routine daily cleaning, and weekly and monthly maintenance schedules during the spraying period will help maximize the life expectancy and performance of sprayers. Standardizing hand-compression spray pumps and operator calibration procedures will also contribute to prolonging the life of the sprayers. All spray supervisors, team leaders and spray operators should be able to dismantle and reassemble the sprayer without assistance. Efforts should be made to provide adequate facilities and equipment for field preventive maintenance and for repairing hand-compression sprayers.

3.2.2 Calibrating the sprayer nozzle

Spray operators must calibrate the nozzle with water in the tank using the following procedure:

- operate the sprayer to ensure working pressure is reached (4 bar or 58 psi);
- open the trigger or on/off valve for 1 minute, collect the discharge and measure the amount in a measuring jug; and
- repeat three times and calculate the average discharge per minute. The correct discharge of a 8002E nozzle at 1.5 bar CFV or 22 psi pressure is 550 ml per minute. The correct discharge of an 8002E nozzle at 3 bar or 45 psi is 800 ml per minute.

Nozzle tips are considered worn if the flow rate exceeds the rate of a new tip by 10%. Therefore, based on a pressure of 1.5 bar, we can say that 550 ml is normal for an 8002E nozzle, and between 550 ml and 605 ml means worn but serviceable, but a flow rate of over 605 ml means the nozzle should be discarded and replaced.

Operators should calibrate their sprayers regularly to ensure correct discharge rate and detect any problem with flow rate which could be due to worn out nozzle or malfunctioning CFV. If there is no spray coming out of the nozzle, it is likely to indicate clogging. This clogging, however, is most likely to be due to a blockage in the nozzle rather than the CFV, since the orifice on the nozzle tip is smaller.

Note: 1.5 bar = 150 kPa = 22 psi

3.2.3 Maintenance and cleaning of the sprayer

The sprayer must be cleaned at the end of every day's spraying. Routine maintenance, cleaning and checking of sprayer equipment is critical to any spray programme. Well-maintained sprayers are less likely to have costly breakdowns. Maintenance also:

- prolongs the lifespan of the sprayer;
- ensures more efficient application – avoids applying more insecticide than necessary and avoids leakage. Well-maintained sprayers will prevent contamination of the spray operator, other people, animals and the environment; and
- saves time: a major fault or breakdown can be inconvenient if spares are not readily available.

Maintenance should not only be carried out when something in the sprayer breaks or when some obvious fault is noticed, but must be a regular activity:

- always carry out at the end of the day;
- empty the tank of spray mix;
- fill the tank to approximately a quarter of its volume with water until the water becomes clear;
- close the lid, pressurize and agitate the sprayer. Spray some of the water through the nozzle to ensure the hose lance and nozzle are cleaned. Discharge the water in a container or dispose of appropriately;
- release the pressure;
- empty the rest of the water using recommended methods;
- repeat the process at least twice with clean water;
- save and recycle water to use for cleaning sprayers the next day through the progressive rinse method (see below);
- at the end of the season, dispose of all wastewater in an evaporation pit or other approved method;
- clean nozzle components in bucket of water. Do not blow into nozzle;
- clean the outside of the sprayer including the straps. Keep cloths or sponges that are to be used ONLY for this purpose; and
- remove lid and store sprayer hung upside down for drainage.

Annex A1.11 and A1.12 provide checklists for monitoring effective cleaning and maintenance of sprayers in the field.

The progressive rinse method

The progressive rinse method is used to rinse and clean spray pumps. The method entails washing the spray pump using a series of plastic containers, which are alternatively either empty or filled with clean water (i.e. barrel 1 empty, barrel 2 filled, barrel 3 empty, etc). The rinse water is saved and used the next day for making up spray solution. Rinse water **MUST NOT** be disposed of into the environment. The steps to carry out a progressive rinse are as follows:

- At the end of the day, spray teams return to their staging areas, sprayers are depressurized and left-over insecticide is poured into the first container (No. 1; empty)
- The operator then adds 1–2 litres to the sprayer from the second container (No. 2; filled with clean water)
- The sprayer is then closed and pressurized to approximately 25 psi (2 bar), shaken so all inside surfaces are rinsed and the contents sprayed into the third container (No. 3; empty)
- Once the sprayer is empty, it is depressurized and the remaining contents are also poured into container No. 3
- The operator repeats the process at the next two stations – containers No. 4 (full) and 5 (empty) and containers No. 6 (full) and 7 (empty)
- The other parts of the pump (i.e. nozzles, filters and lances) can be washed with clean water in a dish or bucket. However, the wastewater resulting from this should then be added to the other rinse water.

Upon completion of these stages, the sprayers have gone through a triple rinse procedure that produces clean rinse water. At this point, the sprayers are considered cleaned. The rinse water generated in this fashion, however, is kept in the rinse containers and is **NEVER** disposed of in the environment. The next day, about 1–2 litres of the rinse water is poured into each sprayer and once at the target area each sprayer can be filled to its capacity with clean water, and charged with pesticide for the day's operations. The process continues on a daily basis until the spray season ends. At this point, the rinse water can be decontaminated following appropriate methods recommended by national and international guidelines for safe disposal of chemical waste.

3.2.4 Troubleshooting on the hand-compression sprayers

The following are the most commonly found sprayer faults.

1. *Control valve does not shut off*: Clean O-ring and seating surface on control valve. Replace O-ring if worn.
2. *Leaks where wand joins control valve*: Clean O-ring in lance and sealing surfaces. Replace O-ring if worn.
3. *Tank does not pressurize when handle pumped*: Lubricate plunger cup with petroleum jelly (not oil), or replace plunger cup.
4. *Leaks where cap joins wand*: Clean O-ring on wand and sealing surfaces. Replace O-ring if worn.
5. *Leaks where pump seals at tank*: Clean gasket sealing surfaces or replace gasket.
6. *Air leaks at hose connection*: Ensure gasket is tight. If O-rings are used, clean sealing surfaces or replace O-rings; re-attach hose. Do not use plastic as a replacement for O-rings or gaskets on the trigger handle as this will affect its structural integrity and may damage it.
7. *Liquid or air enters pump cylinder*: Clean check valve sealing surface or replace check valve.

3.2.5 Spare parts and maintenance tools

Each spray team should have adequate tools and a designated spray operator to conduct field preventive maintenance and repair of spray equipment. Basic tools required include two crescent or adjustable wrenches; one Phillips and one flat-head screwdriver; and two pairs of pliers. For certain sprayers a universal tool kit may be supplied with the sprayer.

Sprayers must be provided with an illustrated manual by the manufacturer. This manual provides:

- a description of the equipment
- operating instructions
- maintenance instructions
- information on how to solve most problems
- a list of spare parts.

Each spray team should have a plastic-bound, illustrated manual for reference.

Spare parts should always be available, especially gaskets, valves and nozzles. When ordering from the manufacturer or a local supplier, give the sprayer model, part name and identification number.

3.2.6 Spray equipment transport and storage

All sprayers should be secured upright in the vehicle (only after pressure is released) to prevent accidental damage during transport between field camps and spray site or while relocating field camps to new areas.

All spray equipment and associated items (e.g. tools, spare parts) should be cleaned at the conclusion of the spray season and stored in a centralized location in the district.

Spray operators must remember to carry out the following:

- inspect each sprayer for damage and repair if necessary;
- prepare an inventory of material needed to replace items lost or damaged during the spray season;
- put a small amount of oil on the leather cup of the pump plunger;
- remove and clean 'in-line' filter;
- store compression sprayers upside down, upright and separate from other field equipment; and
- after storage, check each sprayer to make sure it is in working order before it is sent back to the field.

3.3 Human safety and environmental protection

3.3.1 Occupational safety

Spray operators must always be provided with personal protection devices and clothing including gloves, hats, goggles or clear plastic visors (to protect their faces and eyes when spraying overhead), washable cotton overalls and field boots.

It is essential that all protective clothing and gear is bought locally before every season to ensure it is the right size and comfortable for use by spray operators.

A minimum of two sets of protective clothing should be provided. Ideally, these should be different colours for use on different days to indicate which have been washed after a day's spraying. Extra care must be taken when spraying organophosphates.

Spray operators should be checked for any side-effects including complaints of transitory skin burning or eye watering.

Special considerations for carbamate and organophosphate insecticides

The WHO Expert Committee on Vector Biology and Control has considered worker safety when applying carbamates and organophosphates and gives the following information (2):

- carbamates – no testing required;
- pirimiphos-methyl and malathion – safe enough to be applied operationally without requiring routine cholinesterase monitoring, provided protective clothing is regularly cleaned and a high standard of personal hygiene is maintained;
- fenitrothion – at the limit of acceptable toxicity for conventional indoor application. Its relatively narrow safety margin calls for strict precautionary measures and regular cholinesterase monitoring of exposed people throughout the spraying operation;
- propoxur – no cholinesterase monitoring required (it is a carbamate) but conclusions on use are similar to those with fenitrothion (i.e. it is at the limit of acceptable toxicity with narrow safety margins and strict precautionary measures must be followed).

Fenitrothion is rarely used as an IRS chemical, but if it is, the following guidelines should be observed (3).

In applying *fenitrothion* and *diazinon*, strict precautionary measures should be observed, including daily washing of overalls and use of cloth face masks, broad-brimmed hats and shoes or boots. Mixers and baggers handling the concentrate should also wear rubber boots, gloves and aprons. Any concentrate that gets onto the skin should be washed off at once. Clothes that are wetted with the insecticide should be changed immediately. Operators should not be exposed to the insecticide for longer than the predetermined working hours (usually 5–6 hours). Transport should be arranged to minimize delays between the end of a day's operations and return to base for showering, which should be mandatory. Once a week, all personnel exposed to the insecticide should be examined and their cholinesterase activity determined. Operators should be withdrawn from exposure if their cholinesterase activity decreases to 50% or more of that before exposure. Field tintometric assays are commercially available.

3.3.2 Insecticide poisoning and first-aid measures

Failing to follow correct procedures during spraying operations can result in undesired exposure to insecticides or accidental insecticide poisoning. Below are some of the signs and symptoms of insecticide poisoning:

- *general* – extreme weakness and fatigue;
- *skin* – irritation, burning, excessive sweating, obvious staining;
- *eyes* – irritation, burning, excessive running, blurred vision, narrowing or widened pupils;
- *digestive system* – burning in mouth and throat, excessive salivation, nausea, vomiting, stomach cramps or pains, diarrhoea;
- *nervous system* – dizziness, confusion, restlessness, headaches, muscle twitching, staggering, slurred speech, fits or convulsions, unconsciousness; and
- *respiratory system* – breathing with difficulty, wheezing, coughing, chest tightness and pain.

The routes of entry, possible prevention and general first aid measures are tabulated below. (*Note:* Spray operators should always read and follow instructions on product labels.)

TABLE 7
Prevention and treatment of poisoning

ROUTE OF ENTRY	PREVENTION/PROTECTION	FIRST-AID MEASURES
Skin	Proper application techniques; Proper skin protection including use of gloves and protective clothing; Clean protective equipment before reuse.	Remove contaminated clothing and wash skin with soap and water
Eyes	Use of eye protection (face shield or goggles)	Flush eyes with clean water for at least 15 minutes
Respiratory system	Avoid inhalation of fine dust and mist by using face masks	Move to fresh air

3.3.3 Treatment of insecticide side-effects

Local health units and hospitals should be provided with simple information on the side-effects of insecticides being used and on recommended treatment (4). In addition, supplies should be checked regarding availability of antidotes.

If suspected poisoning occurs the spray operator should seek medical help and show the empty sachet or a product label to a health professional in order to identify the source of poisoning.

The key products or antidotes that should be available for treatment are:

- topical vitamin E (tocopherol acetate) for skin exposure
- topical anaesthetic for eye exposure
- atropine for ingestion exposure
- diazepam for ingestion exposure
- phenytoin for ingestion exposure.

3.3.4 Recycling and waste management

Insecticides can be hazardous to people and to the environment if they are not properly managed. Insecticide management should always include minimizing waste by recycling and disposing of empty sachets or containers through special incineration. This should be done at appropriate facilities designed for this specific purpose.

IRS supervisors and team leaders are responsible for ensuring that their teams follow the progressive rinse method or that they recycle water used for washing sprayers; ensuring that

TABLE 8
Waste minimization management guide

WAYS IN WHICH INSECTICIDE WASTE CAN BE GENERATED	WAYS TO MINIMIZE WASTE GENERATION OR DISPOSAL
Surplus spray solution	Proper planning of needs; Prepare only enough insecticide to spray the area to be covered; Do not leave spray mixture in sprayer overnight
Empty chemical containers e.g. sachets, bottles, drums	Collect and return empty containers to a central location for safe storage, destruction, incineration or burial
Sprayer leakages contaminating absorbent material	Mend leakages in sprayer to avoid spillages
Little or no agitation (especially with DDT) resulting in sediment in pump that requires disposal; Sprayer washing and rinsing	Constant agitation during spraying to avoid sedimentation; Implement progressive rinse method using appropriate containers and recycle rinsing water for next day's use
Chemical fall/bounce back out during spraying	Correct spray technique

Further information on human safety and environmental protection can be found at the WHOPES Website at <http://www.who.int/whopes/recommendations/en/>

insecticide spillages are cleaned; and ensuring that contaminated materials are disposed of through incineration. Special attention should be given to preventing contamination of food and of the floor areas of houses where children and animals would be especially exposed.

3.4 Spray application supervision

IRS spray application requires close supervision from team leaders, IRS supervisors and IRS coordinators in order to be successful. This should be provided daily by the team leader, weekly by the IRS supervisors, and monthly by the IRS district coordinators throughout the period of the spray operations. It may be important that communities are informed of proper mixing volumes so that when spray operators are mixing insecticides and sprayer charges, villagers can be assured that spray is not being incorrectly diluted. Inspections should be based on the approved forms and checklists to ensure uniformity, accuracy and completeness. The national and provincial teams should try to ensure that there are joint inspections with ministries of environment and agriculture so they are also fully aware that full environmental standards are being maintained.

3.4.1 Purpose of supervision

The role of the supervisor is to solve problems and to offer support, not to criticize or find fault. The main objectives are to:

- ensure that the spray team movement schedule is strictly adhered to and the agreed target numbers of houses to be sprayed per day are being maintained;
- take immediate corrective measures on spray application techniques and take note of any equipment deficiencies for remedial action;
- motivate, stimulate, encourage and advise on good communication with householders and village or community leaders;
- ensure good teamwork for total and complete coverage of areas to be sprayed;
- ensure that strict discipline and standard operating procedures are maintained;
- assess, evaluate and encourage the work output of the teams; and
- make constructive and feasible recommendations to improve quality, coverage and timely implementation of operations.

Scheduled spot checks on all spray teams allow for assessment of quality and work performance as well as monitoring coverage. Feedback on operational deficiencies should be given to the team leader and IRS field supervisors so that they can take remedial measures. Equipment must be checked regularly.

3.4.2 Supervisory tools

Supervision should be conducted using standard forms and checklists to ensure uniformity, accuracy and completeness of information. Annex A1.13 gives an example of a typical supervision checklist. Tools and checklists for supervision need to be simple, clear and short; ideally, not more than one page in length. A comprehensive IRS supervision inspection checklist, a tool to verify country programme preparedness to safely implement IRS and minimize environmental contamination, is provided at Annex A1.14.

Provincial and district IRS coordinators, disease control officers and entomologists should conduct field visits to supervise IRS, note operational problems and correct them on the spot using the same standardized checklists.

3.5 Important health and environmental safeguards necessary for IRS operations

- Extensive pre-intervention spray operator training is required to ensure that IRS is conducted safely and effectively.
- Supervision of IRS operations is required to ensure that the spray operators apply the relevant health and environmental safeguards.
- Regular monitoring and evaluation is required to ensure that international best practices and standards are followed.
- The potential health risks of malaria infection far outweigh the potential health risks of the insecticides, when used as recommended.

3.6 References and web links

1. Adapted from Lluberas, M. Code of conduct for spray team members. American Mosquito Control Association, Wing Beats Magazine, Summer 2012: 25–27 (<https://amca.memberclicks.net>, accessed 18 January 2013).
2. World Health Organization. Safe use of pesticides. Third report of the WHO Expert Committee on Vector Biology and Control. Geneva, 1979. WHO technical report series, 634: 17–18 (http://whqlibdoc.who.int/trs/WHO_TRS_634.pdf, accessed 8 January 2013).
3. World Health Organization. Pesticides and their application: for the control of vectors and pests of public health importance. Sixth edition. Geneva, 2006 (http://whqlibdoc.who.int/hq/2006/WHO_CDS_NTD_WHOPES_GCDPP_2006.1_eng.pdf, accessed 10 January 2013).
4. Reigart JR, Roberts JR. Recognition and management of pesticide poisoning. Fifth edition. Washington, United States Environmental Protection Agency, 1999 (<http://www.epa.gov/oppfead1/safety/healthcare/handbook/Front.pdf>, accessed 8 January 2013).
5. World Health Organization. Equipment for vector control – specification guidelines. Revised version. Geneva, 2010 (<http://www.who.int/whopes/equipment/en/>, accessed 8 January 2013).



Useful resources and web links

Chapter 1: IRS policy and strategy

Malaria: Global Technical Strategy: 2016–2030

http://www.who.int/malaria/areas/global_technical_strategy/draft_strategy/en/

Global Malaria Action Plan 2: Action and Investment to defeat Malaria

<http://www.gmap2.org/english/home>

Integrated Vector Management:

http://www.who.int/neglected_diseases/vector_ecology/en/

- WHO position statement on integrated vector management
- Global strategic framework for integrated vector management
- Core structure for training curricula on integrated vector management
- Handbook for integrated vector management
- Guidance on policy-making for integrated vector management

WHO Expert Committee on Malaria: twentieth report:

http://whqlibdoc.who.int/trs/WHO_TRS_892.pdf

Vector control for malaria and other mosquito-borne diseases: report of a WHO study group.

WHO technical report series, 857:

http://www.who.int/malaria/publications/atoz/who_trs_857/en/index.html

Malaria vector control: decision making criteria and procedures for judicious use of insecticides:

http://whqlibdoc.who.int/hq/2003/WHO_CDS_WHOPES_2002.5_Rev.1.pdf

Global Plan for Insecticide Resistance Management in malaria vectors (GPIRM):

http://www.who.int/malaria/vector_control/ivm/gpirm/en/

WHO interim position statement – the role of larviciding for malaria control in sub-Saharan Africa:

http://www.who.int/malaria/publications/atoz/larviciding_position_statement/en/

Chapter 2: Management of an IRS Programme

Epidemiological Surveillance

Disease surveillance for malaria control and elimination operational manuals (2012):

<http://www.who.int/malaria/areas/surveillance/operationalmanuals/en/>, accessed 15 May 2015

Malaria indicator survey: basic documentation for survey design and implementation. Roll back malaria monitoring and evaluation reference group:

<http://www.who.int/malaria/publications/atoz/9241593571/en/index.html>

Malaria elimination: a field manual for low and moderate endemic countries:

<http://www.who.int/malaria/publications/atoz/9789241596084/en/>

Indicators to measure the impact of malaria control:

<http://www.who.int/malaria/publications/atoz/whocdsrbm200022/en/index.html>

Entomological Surveillance

Entomological field techniques for malaria control. Part I: learner's guide; Part II: tutor's guide:

<http://www.who.int/malaria/publications/atoz/9241544392/en/index.html>

Manual on practical entomology in malaria:

[http://whqlibdoc.who.int/offset/WHO_OFFSET_13_\(part1\).pdf](http://whqlibdoc.who.int/offset/WHO_OFFSET_13_(part1).pdf)

Test procedures for insecticide resistance monitoring in malaria vectors, bio-efficacy and persistence of insecticides on treated surfaces:

http://www.who.int/malaria/publications/atoz/who_cds_cpc_mal_98_12/en/

Supplies for monitoring insecticide resistance in disease vectors – procedures and conditions:

http://www.who.int/malaria/publications/atoz/who_cds_cpe_pvc_2001_2/en/index.html

Selection of insecticides

Decision-making for judicious use of insecticides (Facilitator's guide and Participant's guide):

http://whqlibdoc.who.int/hq/2004/WHO_CDS_WHOPES_2004.9b.pdf

http://whqlibdoc.who.int/hq/2004/WHO_CDS_WHOPES_2004.9a.pdf

Use of DDT

The use of DDT in malaria vector control: WHO position statement on DDT:

http://www.who.int/malaria/publications/atoz/who_htm_gmp_2011/en/

Insecticide use code of conduct and other international instruments

International code of conduct on the distribution and use of pesticides:

<http://www.fao.org/docrep/005/Y4544E/y4544e00.htm>

Rotterdam convention on the prior informed consent procedure for certain hazardous pesticides and industrial chemicals in international trade:

<http://www.pic.int/Default.aspx?tabid=855>

Stockholm convention on persistent organic pollutants:

<http://chm.pops.int/>

Guidelines on public health pesticide management policy for the WHO African Region | French:

http://whqlibdoc.who.int/publications/2011/9789241501231_eng.pdf (English)

http://whqlibdoc.who.int/publications/2011/9789242501230_fre.pdf (French)

Guidelines on public health pesticide management policy for the WHO South-East Asia Region:

http://www.who.int/whopes/resources/SEA_CD_214.pdf

Storage

Pesticide storage and stock control:

<http://www.fao.org/docrep/V8966E/V8966E00.htm>

Procurement and registration

Guidelines for procuring public health pesticides:

http://whqlibdoc.who.int/publications/2012/9789241503426_eng.pdf

Guidelines for quality control of pesticides:

http://whqlibdoc.who.int/hq/2011/WHO_HTM_NTD_WHOPES_2011.4_eng.pdf

Guidelines for the registration of pesticides:

http://whqlibdoc.who.int/hq/2010/WHO_HTM_NTD_WHOPES_2010.7_eng.pdf

Guidelines on public health pesticide management policy for the WHO African Region:

http://whqlibdoc.who.int/publications/2011/9789241501231_eng.pdf

Insecticide Resistance

Global Plan for Insecticide Resistance Management in malaria vectors (GPIRM):

http://www.who.int/malaria/vector_control/ivm/gpirm/en/

Insecticide resistance action committee: prevention and management of insecticide resistance in vectors and pests of public health importance:

<http://www.irc-online.org>

Equipment

Equipment for vector control – specification guidelines:

http://whqlibdoc.who.int/hq/2006/WHO_CDS_NTD_WHOPES_2006.5_eng.pdf

Pesticides and their application, for the control of vectors and pests of public health importance:

http://whqlibdoc.who.int/hq/2006/WHO_CDS_NTD_WHOPES_GCDPP_2006.1_eng.pdf

Occupational safety

Recognition and management of pesticide poisonings:

<http://www.epa.gov/oppo0001/safety/healthcare/handbook/handbook.htm>

Safe use of pesticides. Third report of the WHO Expert Committee on Vector Biology and Control. WHO technical report series, 634 (1979) [recommendations on spray operator safety with carbamate and organophosphate insecticides]:

http://whqlibdoc.who.int/trs/WHO_TRS_634.pdf

Sound management of pesticides and diagnosis and treatment of pesticide poisoning – a resource tool:

http://www.who.int/whopes/recommendations/IPCS_Pesticide_ok.pdf

Generic risk assessment model for indoor residual spraying of insecticides – first revision:

http://whqlibdoc.who.int/publications/2011/9789241502177_eng.pdf

The WHO recommended classification of pesticides by hazard:

http://www.who.int/ipcs/publications/pesticides_hazard/en/

Environmental Safety

President's Malaria Initiative BMP manual. Best management practices (BPM) for indoor residual spraying in vector control interventions:

http://www.pmi.gov/docs/default-source/default-document-library/tools-curricula/bmp_manual_aug10.pdf?sfvrsn=4, accessed 15 May 2015

Guidelines for the management of small quantities of unwanted and obsolete pesticides:

<http://www.fao.org/docrep/X1531E/X1531E00.htm>

Budgeting and costing

PEEM guidelines 3: Guidelines for cost-effectiveness analysis of vector control:

http://www.who.int/malaria/publications/atoz/who_cds_93_4/en/index.html

An economic analysis of the costs of indoor residual spraying in 12 PMI countries, 2008–2010:

<http://www.pmi.gov/how-we-work/technical-areas/indoor-residual-spraying>, accessed 13 May 2015

IRS campaign budget template (Excel workbook):

http://www.rollbackmalaria.org/microsites/archive/newsletters_2006_2015/tool_irstoolkit.html, accessed 13 May 2015

Chapter 3: Conducting a house spray

Manual for indoor residual spraying. Application of residual sprays for vector control. Third edition:

http://whqlibdoc.who.int/hq/2007/WHO_CDS_NTD_WHOPES_GCDPP_2007.3_eng.pdf

IRS training guide for spray operations:

http://www.pmi.gov/docs/default-source/default-document-library/tools-curricula/irs_training.pdf?sfvrsn=4, accessed 15 May 2016

ANNEX 1

IRS checklists and forms



Contents

A1.1	Example of sprayable surface record form for baseline estimation of insecticide quantification needs	95
A1.2	Example of house spray card	96
A1.3	Example of annual reporting on insecticides used for vector control	97
A1.4	Timeline for implementation of IRS	98
A1.5	Example of capital and operational budgets for an IRS campaign	100
A1.6	Code of conduct	101
A1.7	Examples of IRS operations organizational charts	103
A1.8	Example of daily reporting form for spray operators	105
A1.9	Example of daily/weekly reporting form for spray team leaders	106
A1.10	Example of monthly reporting form for district IRS coordinators	107
A1.11	Example of checklist for cleaning the sprayer in the field	108
A1.12	Example of checklist for maintenance of sprayers	109
A1.13	Example of spray team leader and IRS supervisor's checklist	110
A1.14	Example of IRS supervision inspection checklist	111

A1.1 Example of sprayable surface record form for baseline estimation of insecticide quantification needs

(This is for initial quantification purposes only, not for use in all IRS spray operations)

HOUSEHOLD NUMBER	GPS COORDINATES	TYPE OF HOUSE	DIMENSIONS OF SURFACES					TOTAL SURFACE AREA (SQ METER)	
			EAVES (LxW)	ROOM 1 (LxH) x 2 + CEILING(WxL)	ROOM 2 (LxH) x 2 + CEILING(WxL)	ROOM 3 (LxH) x 2 + CEILING(WxL)	ROOM 4 (LxH) x 2 + CEILING(WxL)		KITCHEN (LxH) x 2 + (WxH) x 2 + CEILING
1									
2									
3									
4									
5									
6									
7									
8									
9									
10									
11									

A1.3 Example of annual reporting on insecticides used for vector control

Completed by: Name
 Postal address

 Tel: Fax: Email:
 Date: month/year.....

YEAR	COMPOUND	CLASS	FORMULATION	CONCENTRATION	TYPE OF APPLICATION	FOR CONTROL OF	AMOUNT OF FORMULATION USED (KG OR L)	AMOUNT OF A.I.
2010	DDT	Organochlorine	75WP	75%	Indoor residual spraying	Malaria	1000 kg	
	Deltamethrin	Pyrethroid	25WG	25%	Indoor residual spraying	Malaria	1000 kg	

A1.5 Example of capital and operational budgets for an IRS campaign

ITEM	NO OF UNITS	UNIT COST	TOTAL COST
CAPITAL			
Baseline epidemiological and entomological review and survey			
Environmental impact assessment			
Compression sprayers			
Equipment, spares and replacement parts			
Tool kits			
Protective sheeting to cover household goods			
Transport: truck/boats for 3–4 spray teams			
Transport: supervisors' motorcycles			
Transport: coordinators' 4x4s			
Malaria camps – storage and base			
RECURRENT			
Spray insecticides			
Salaries of spray operators for 4–8 weeks (adjust to minimum wage)			
Personal protective equipment (overalls, gloves, helmets, face shields with screen)			
Collection and disposal of empty sachets and containers			
Travel and per diems for supervisors and coordinators for duration of the campaign			
Transport hire and fuel costs			
Annual training of coordinators and supervisors			
Annual training of spray operators			
Annual IEC and community mobilization materials			
Annual review of environmental compliance and pesticides management			
Monthly, quarterly and annual operations management meetings			
IRS data entry and summary report sheets			
Malaria prevalence surveys (optional)			
Entomological studies and sentinel sites			
Annual post-spray review and annual report production			

A1.6 Code of conduct

(Adapted from Lluberas, M. Code of conduct for spray team members. American Mosquito Control Association, *Wing Beats Magazine*, Summer 2012: 25–27).

The following code of conduct incorporates features of a code currently being used successfully in several malaria vector-control programmes in sub-Saharan Africa. It is given here as an example for use in other programmes.

Indoor residual spray team members, including spray operators and team leaders/supervisors, have a duty to always act in a professional manner and maintain good relations with the villagers. Their behaviour and demeanour should be beyond reproach. Spray team personnel should never say or do anything to each other or to a member of the community that will upset or offend local leaders, householders or their customs. Sometimes spray teams will be offered food. Accepting these gifts should be discouraged as it may cause undue hardship to householders where food and/or water may be in short supply or difficult to obtain. Therefore, spray team members must provide their own food and/or snacks at all times and in all locations. All members must agree to comply with the following:

Rule 1: Spray team members must wear their uniform properly and maintain it in clean, good working order.

Rule 2: Spray team members must properly wear their personal protective equipment (PPE) while spraying.

Rule 3: Spray team members must be respectful and courteous towards household residents and their property at all times.

Rule 4: Spray team members must never ask villagers to provide food, money or water for their sprayers.

Rule 5: Spray team members, particularly the team leaders, should give clear instructions to the residents so they can adequately protect themselves, their family members and domestic animals and pets from exposure to the insecticide applied. They should also instruct the householders to sweep the floor of the house and the ground immediately around it of all dead insects, and burn or bury them during the course of 2 days after spraying.

Rule 6: Spray team members must comply with all directives given by their team leaders and programme managers.

Spray operators

Spray operators are often selected from the community and employed for a period ranging from a few weeks to a few months, depending on the complexity of the campaign. They are trained to apply insecticide. They should, under the jurisdiction of the ministry of health or other pertinent local authority undertaking the IRS campaign, be able-bodied, able to work with minimum supervision, and able to read and write. Spray operators should be at least 18 years old, physically fit, healthy and able to operate the sprayer. If women are employed, they must understand that they must not be pregnant or lactating at the time of recruitment or become pregnant during any part of the spray campaign, and that pregnancy can be grounds for relocation away from active spraying. Spray operators should be responsible persons who can communicate with residents. Once teams are selected, spray operators are trained in the proper insecticide application techniques, effective communication and record keeping.

Duties of spray operators

- report for duty on time and ready to work;
- respect local customs, laws and regulations;
- keep his/her sprayer, tools, personal protection, etc. clean and in good working order and assume total responsibility for all the equipment under his/her care;
- apply all insecticides following the programme's procedures, protocols and directives, and be accountable for all insecticide sachets issued to him/her;
- wear personal protective equipment as instructed while spraying and protect himself/herself and the environment from insecticide contamination;
- maintain accurate records of his/her activities while on duty as a spray operator;
- be courteous and respectful to the householders and residents and their property;
- conduct complete and comprehensive spraying of assigned homes;
- explain the purpose of spraying and the precautions being taken as well as answering any question posed by the resident or his/her family;
- assist the householder, if necessary, to move furniture and other belongings;
- report any problem to his/her team leader as soon as they arise;
- carry out instructions given by the team leader in a timely fashion;
- thank each householder for cooperating on completion of the work, and answer or address any concerns the householder may have.

Duties of team leaders and supervisors

- assist in the training of spray operators and guide them in the proper completion of their duties. Do this according to the established procedures and protocols, and in a timely fashion;
- keep all spray personnel up to date and informed as to their progress and that of the campaign;
- continually and routinely check their team members to make sure their equipment is kept clean and in working condition;
- carry out or supervise minor field repairs to sprayers and personal protective equipment;
- supervise his/her spray team members during spraying operations and ensure their work is carried out according to instructions and following established protocols and procedures;
- conduct sporadic checks on application equipment and nozzles so that appropriate discharge and application rates are maintained;
- ensure his/her team members have adequate supplies of insecticide, water, record cards, replacement personal protective equipment, etc.;
- ensure that zone maps are always available (or produced) and are updated as his/her team members progress from village to village;
- ensure home owners and residents are notified of spray operations at least a day in advance;
- contact the village leaders as soon as his/her spray squad enters the village;
- make appropriate corrections on method or technique not executed correctly by any of his/her team members;
- verify that spraying has been conducted according to the established plan upon completion of the day's work;
- ensure all data recorded by team members is correct and accurate and rectify any deficiencies noted;
- prepare daily progress reports accurately at the completion of daily spraying;
- supervise the cleaning of application equipment at the end of the day's work;
- report to the supervisor the progress of the squad and include remarks on the work of each spray operator;
- carry out any other instructions given by his/her superior or any other senior programme officer; and
- ensure each team member in his/her team maintains a professional image and conducts himself/herself with cultural sensitivity.

A1.7 Examples of IRS operations organizational charts

Example 1: Organization at central level

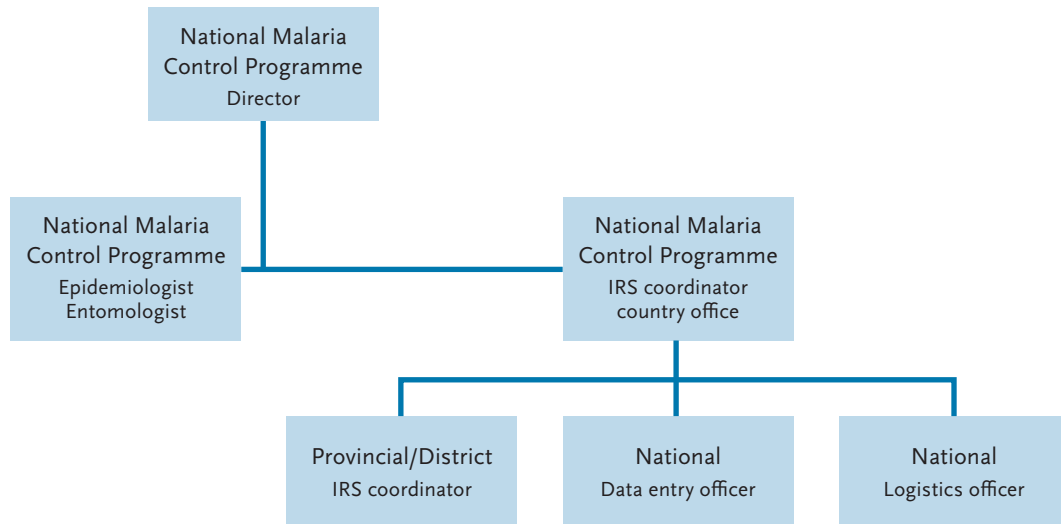

Example 2: Organization at provincial/district level

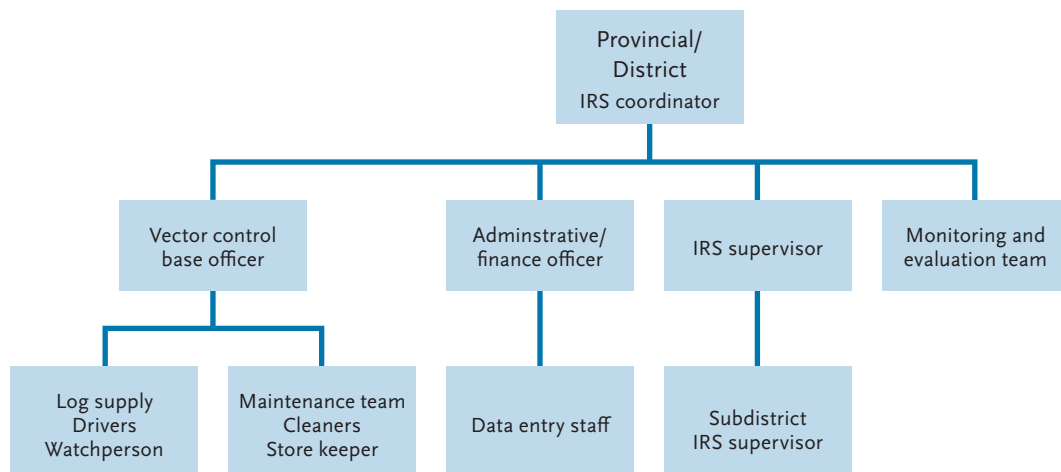

Example 3: Organization at subdistrict level

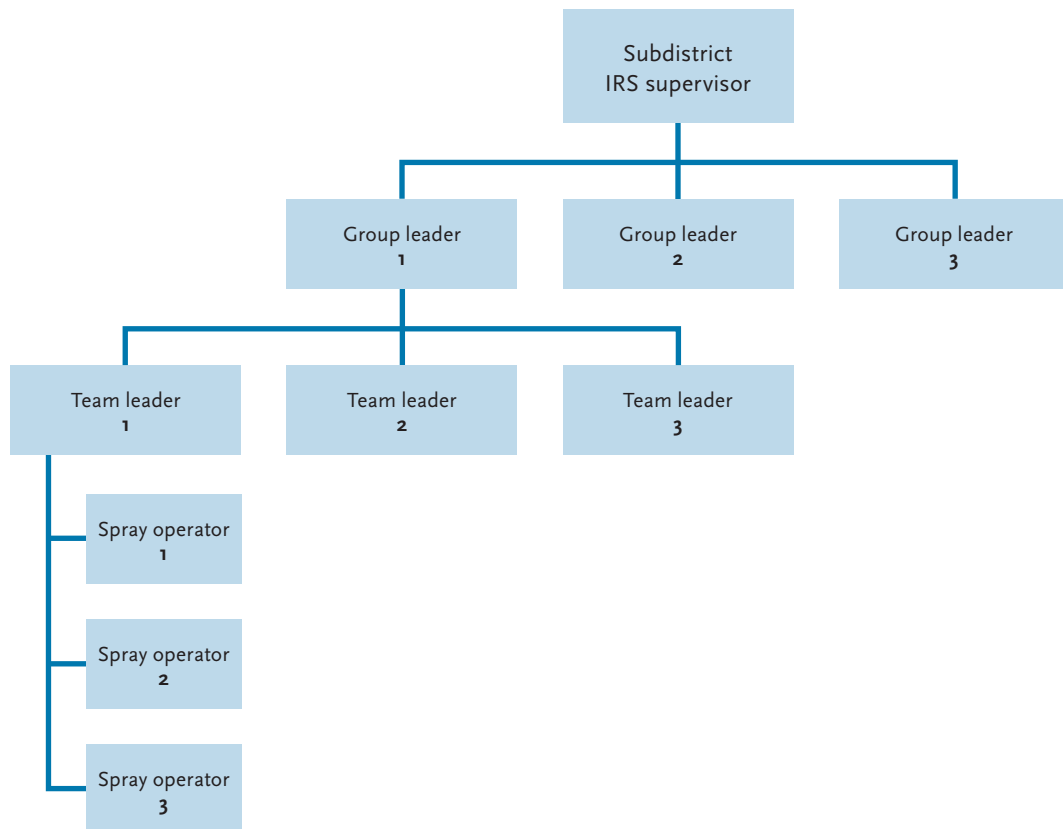

A1.8 Example of daily reporting form for spray operators

District Parish/Ward Village Date
 Name and ID No. of Spray Operator Signature

NO.	TARGET HOUSE-HOLD ID NUMBER	TARGET HOUSEHOLD GPS NO.		NO. OF PEOPLE IN HOUSEHOLD		TOTAL NO. OF ROOMS/STRUCTURES/UNITS IN HOUSEHOLD		TOTAL NO. OF ROOMS/STRUCTURES/UNITS IN HOUSEHOLD UNSPRAYED		NO. OF MOSQUITO NETS HANGING	NO. OF LONG-LASTING NETS OR THOSE RETREATED IN THE LAST YEAR
		LATITUDE	LONGITUDE	CHILDREN	ADULTS	TRADITIONAL	MODERN	LOCKED	REFUSED (SEE KEY)		
1											
2											
3											
4											
5											
6											
7											
8											
9											

KEY TO REFUSALS

SC: sick	NB: newborn	F: funeral	O: other
----------	-------------	------------	----------

Insecticide used: Compound Formulation Dosage concentration
 Total number of insecticide sachets/bottles issued for the day
 Total number of empty sachets bags/bottles returned
 Spray operator's remarks on operational problems and suggested solutions

Spray team leader's daily calculation
 1. Daily household coverage (Total number of sprayed houses/Total number of houses):
 2. Daily rooms/structure coverage (Total number of sprayed rooms/structures/Total number of rooms/structures):
Spray team leader's remarks
 Signature of spray operator.....

A1.11 Example of checklist for cleaning the sprayer in the field

Checklist for cleaning the sprayer in the field

- When is the sprayer to be cleaned?**
 - At the end of the day's spraying
 - If changing from one product to another
- What protective clothing should be worn when cleaning the sprayer?**
 - Long trousers
 - Long-sleeved shirt
 - Eye protector/goggles
 - Gloves
 - Boots
 - Apron
 - Mouth/nose masks
- Is the correct cleaning procedure being followed?**
 - Empty the spray tank of spray mix through progressive rinse into plastic containers (note disposal procedure)
 - Fill tank to about $\frac{1}{4}$ of its volume with clean water, close lid and shake
 - Spray some of the water through nozzle and lance to clean hose, lance and nozzle
 - Empty rest of water from tank into progressive rinse containers (note safety measures and contamination). In the case of DDT, spray pumps should be thoroughly washed at the end of the day by rinsing with clean water (triple rinse). Rinse water should be poured into a dedicated container, tank, mixing drum or water trailer and used the next day for making up the first spray solution. Rinse water **MUST NOT** be disposed of into the environment
 - Repeat the process at least twice with more water
 - Dismantle trigger assembly, cleaning lance filter in bucket of water
 - Dismantle nozzle assembly, clean CFV, nozzle filter and nozzle components in bucket of water
 - Clean outside of sprayer including the straps
 - Do not drain sprayer onto waste ground but recycle the wastewater into progressive rinse containers
 - Store sprayer by removing the lid and hang upside down to fully drain inside the store

WARNING! Do not drain sprayer – a always recycle the wastewater through progressive rinse method.

A1.12 Example of checklist for maintenance of sprayers

Checklist for maintenance of sprayers

District Ward
Evaluator Supervisor Date

Checklist for maintenance schedules

1. Checklist for pre-spray checks

Visual checks:

- Cleanliness of pump Poor Good
 - Strap Poor Good
 - Cleanliness of strap Poor Good
- Fill with water and pressurize and check:
 - Pressure gauge functioning Yes No
 - Pump pressuring smoothly Yes No
 - Pressure retained if left for 5 minutes Yes No
 - Trigger valve stops cleanly – no drips Yes No
 - No obvious leaks or drips at hose connections Yes No
 - No obvious leaks or drips around trigger Yes No
 - No obvious leaks or drips at nozzle Yes No
 - Strap pattern even Yes No

2. Checklist for periodic checks

- All elements of the pre-spray checks (see above)
- Dismantle pump and check
 - Condition of piston and signs of wear Poor Good Very good
 - Condition of outlet valve Poor Good Very good
- Dismantle trigger valve assembly and check
 - Condition of trigger valve for wear Poor Good Very good
 - Condition of seals or O-rings for wear Poor Good Very good
- Reassemble sprayer, fill with water, pressurize and measure
 - Flow rate at full working pressure Poor Good Very good
 - Nozzle discharge pattern Poor Good Very good

Two safety rules for dismantling and checking sprayers

- Always wear gloves and long sleeves when dismantling sprayers.
- Always ensure that sprayer is not pressurized before dismantling.

A1.13 Example of spray team leader and IRS supervisor's checklist

Spray team leader and IRS supervisor's checklist

District

Ward Village

Team leader

Number of spray operators

Name of village being sprayed

Estimate of number of target structures

Name of team leader

What was the spray operator doing on your arrival

Observe the use of protective clothing: Overalls Boots

Mouth/nose mask/face shield Hat Gloves

Procedure before starting to spray:

Are the residents informed? Yes No

Are food items, water containers, cooking utensils covered/ taken outside? Yes No

Are the residents outside during spraying and until 60 minutes after? Yes No

Are domestic animals outside during spraying and until 60 minutes after? Yes No

Spraying technique:

Is the sprayer filled correctly? Yes No

Is the sprayer pressurized correctly? Yes No

Is the sprayer pressure gauge checked frequently and pressure maintained between 245–380kPa (35–55psi) or 2.5–3.8 bar for sprayers without a 1.5 bar CFV? Yes No

Is the sprayer pressure gauge checked and pressure maintained above 200 kPa (29 psi) or 2.0 bar for sprayers with 1.5 bar CFV? Yes No

Is the sprayer handled and carried correctly? Yes No

Is the sprayer shaken periodically before and during spraying? Yes No

Is the nozzle held at a constant distance from the target (45cm?) Yes No

Is the nozzle moved at a constant speed over all surfaces? Yes No

Is proper footwork performed so that adjacent swaths overlap for uniform spray coverage? Yes No

Is the pressure released when the sprayer is not in use? Yes No

Is distribution of insecticide on wall adequate? Yes No

Is distribution of insecticide on roof/ceiling adequate? Yes No

Does spray operator spray behind and under furniture? Yes No

Does spray operator spray under the eaves? Yes No

Does spray operator spray behind the doors? Yes No

Does spray operator avoid environmental pollution? Yes No

Does spray operator eat, drink or smoke without first washing? Yes No

Does spray operator complete daily record form? Yes No

Any comments from household members

Any comments from village or community leaders

Positive feedback

Areas requiring attention and action

Proposed solutions and recommendations

Team leader/ District IRS supervisor's name and signature

A1.14 Example of IRS supervision inspection checklist intended for program and donor to assess country preparedness for quality and safe IRS

IRS Supervision Inspection Checklist 1

Pre-spray storeroom and soak pit inspection

Date of inspection: /...../.....

Country:

District:

County:

Village:

GPS coordinates:

Inspectors:

Security at central warehouse and district storage facility

	MITIGATION ACTIONS	FINDINGS		COMMENTS/ RECOMMENDED ACTIONS	COMPLETION DATE (IF APPLICABLE)
		Yes	No		
1	Is the storage facility located at an adequate distance from schools, homes and water bodies/flood plains ?	Yes	No	Facility located at least 100 m away from residential housing?	
2	Is the storage facility secured including double locks on pesticide storage containers, all windows barred and doors secure?	Yes	No	Strong front door with double locks? Windows secured? (mark with a tick or X where appropriate)	
3	Is the facility guarded 24 hrs/ day with adequate lighting?	Yes	No		
4	Are guards equipped appropriately: boots, whistles, flashlights, phones?	Yes	No		
5	Is the storeroom well ventilated?	Yes	No		
6	If the storeroom is to be used to keep insecticides for longer duration, does it have adequate ventilation and/or exhaust fans working?	Yes	No		
7	Is there adequate lighting inside the store?	Yes	No		
8	Are danger signs and appropriate hazard labels prominently displayed?	Yes	No		
9	Do the compression pumps meet WHO specifications for use in IRS?	Yes	No	Pumps fitted with 8002E nozzle? Fitted with 1.5 bar CFV?	
10	Are technicians available to service compression pumps and fix dysfunctional pumps?	Yes	No		
11	Are the pumps kept dry and properly stored?	Yes	No		

	MITIGATION ACTIONS	FINDINGS		COMMENTS/ RECOMMENDED ACTIONS	COMPLETION DATE (IF APPLICABLE)
		Yes	No		
12	Are the spray pumps properly maintained and is a stock of spare parts available?	Yes	No	1) Pumps serviced once a year 2) Pumps and nozzles (8002E) calibrated prior to spray cycle	
		Yes	No	3) Nozzles cleaned and tested regularly 4) Spare 8002E nozzles available	
13	Is personal protective equipment (PPE) properly maintained?	Yes	No	1) Overall in good condition, cleaned and properly stacked 2) Head gear and boots in good condition, cleaned and properly stacked 3) Are PPEs kept separately and away from equipment and insecticides?	
14	Is the store clear and free of rodents? (Rodents can damage sprayers by chewing hoses)	Yes	No	Rodent traps set in the store?	

Stock review

1	Is there a system for recording stock, and are stock cards up to date?	Yes	No		
2	Are the available stock cards properly filled to enable tracking of stock?	Yes	No	Using stock cards, can warehouse supervisor indicate: a) quantity and age of remaining stock ?, b) quantity of stock that has been used to-date?	
3	Are stock items shelved in an orderly fashion on pallets, according to their type or expiry date?	Yes	No		
4	Does the storeroom have a leak-proof floor and a sump at the entrance to contain major leakage?	Yes	No	<i>The leak-proof floor should drain into a sump so that if the floor is washed, liquid can be collected for appropriate disposal.</i>	
5	If flood risk is unavoidable, what precautions are in place to mitigate the consequences?	Yes	No	1) Raised storage area 2) Proper drainage in place	
6	Does the storeroom have a leak-free roof?	Yes	No		

	MITIGATION ACTIONS	FINDINGS		COMMENTS/ RECOMMENDED ACTIONS	COMPLETION DATE (IF APPLICABLE)
7	Is storage capacity sufficient to store the total stock of insecticides at any time?	Yes	No		
8	Are insecticide containers (boxes, drums etc.) stored on pallets and stacked in a manner that allows for inspection?	Yes	No		
9	Is the maximum storage height (2 m) for insecticide stacks maintained?	Yes	No	<i>If no, then containers must be restacked to bring them in line with the maximum storage height</i>	
10	Are all insecticide containers checked to ensure none are leaking?	Yes	No		
11	Is there a recording thermometer in the pesticide storeroom?	Yes	No	Logbook with regular record of temperature available?	
12	Are functional in-date fire extinguishers or fire-fighting equipment (e.g. bucket of sand) available?	Yes	No	Outside / inside the storeroom, pesticide room, and transport vehicles?	
13	Is there a system for fire extinguishers to be tested and replaced before their expiry dates?	Yes	No	Are all fire extinguishers functional?	
14	Are pesticide labels securely fixed and legible?	Yes	No		
15	Are samples of pesticides taken for quality (QA/QC) ^a analysis?	Yes	No	If no, is there evidence to show the quality of pesticides?	
16	Are any insecticides that are past their expiry date separated from operational stocks?	Yes	No	Expiry date of pesticides in inventory/...../.....	
17	Is there any evidence of pesticide leakage or spill (sign of dust or granules)?	Yes	No		
18	Are barrels or containers for waste available and are these clearly labelled?	Yes	No		
19	Are used sachets or bottles counted and stored neatly in boxed containers or barrels?	Yes	No		
20	Is soap and water available for hand washing after handling insecticides?	Yes	No		
21	Are antidotes to specific pesticides available nearby? <i>(Note: Not all pesticides have an antidote)</i>	Yes	No	Is there a plan for emergency evacuation to health facility in case of accidental poisoning?	

^a QA – Quality assurance; QC – Quality control

	MITIGATION ACTIONS	FINDINGS		COMMENTS/ RECOMMENDED ACTIONS	COMPLETION DATE (IF APPLICABLE)
22	Do storeroom supervisors know the signs of poisoning specific to the pesticides being used, as well as the location of the nearest treatment facility?	Yes	No	Distance to nearest pesticide poison management centre	
23	Are pregnancy test strips in stock for female staff and have preparations been made for tests to be conducted at a nearby clinic or by a nurse?	Yes	No	<i>Pregnant or breastfeeding female spray operators should be assigned tasks other than spraying</i>	
24	Is there an adequate number of supervisor checklists, inventory and monitoring and evaluation forms available?	Yes	No		

Health and safety issues

1	Are pesticide Material Safety Data Sheets (MSDS) readily available?	Yes	No		
2	Are there extra MSDS available for labelling transport vehicles and are drivers trained in the event of an accident?	Yes	No		
3	Is there a plan for maintenance of PPE?	Yes	No		
4	Are instructions provided for the correct use of PPE?	Yes	No		
5	Is there adequate PPE in the inventory for the number of operators expected? (<i>Three pairs of overalls, one set of gloves, boots, headcover and mouth/nose mask per spray operator</i>)	Yes	No	Number of operators to work out of this centre, number of full sets of PPE available	
		Yes	No	Number of available overalls, hand gloves, mouth/nose masks, boots (insert numbers)	
6	Are first-aid kits for the storeroom and for transport vehicles stocked with pain killers (e.g. aspirin, panadol), dressings (e.g. plasters, gauze, tape, bandages) and eye wash?	Yes	No	Number of transport vehicles expected to be used Number of fully stocked first-aid kits	
7	Is the emergency response procedure posted in the stockroom (including phone numbers) and on the notice board at the warehouse?	Yes	No		
8	Is the spill response procedure posted?	Yes	No		

	MITIGATION ACTIONS	FINDINGS		COMMENTS/ RECOMMENDED ACTIONS	COMPLETION DATE (IF APPLICABLE)
9	Are emergency spill kits in place for the storeroom and for vehicles (sand bucket, long-handled brush with stiff bristles, shovel) with instructions included?	Yes	No	Number of vehicles to work out of this operations centre Number of spill kits included in inventory	
10	Is there more than one spray season of accumulated solid waste?	Yes	No	If <u>yes</u> , is there a plan in place for its disposal? When will disposal take place?	
11	If present, are foods, medicines and other products stored separately from pesticides (to prevent contamination)?	Yes	No		
12	Is there someone trained in first aid, specifically in treating pesticide exposure?	Yes	No	If no, is there a plan to provide training?	

Soak pit and washing area

1	Is the soak pit located away from water bodies, steep slopes or flood prone areas?	Yes	No		
2	Are the soak pit and surroundings cleared of vegetation and cleaned?	Yes	No		
3	Is the gravel on soak pit adequate, well placed and able to act as a filter?	Yes	No		
4	Are the washing areas properly sloped to drain to the soak pit, with no leaks or cracks?	Yes	No		
5	Are clothes lines present and are they sufficiently strong?	Yes	No		
6	Are the clothes lines located above the soak pit or wash area?	Yes	No		
7	Are danger signs and appropriate hazard labels posted on all exposed sides of the soak pit?	Yes	No		
8	Is the soak pit sufficiently well-built and is it correctly fenced, gated and locked?	Yes	No	Well-built and fenced? Gated? Locked?	
9	Are showers and toilets with adequate privacy and drainage present at the site?	Yes	No	Separate male / female facilities?	
10	Is there adequate clean water available for rinse management?	Yes	No	Adequate water available for progressive rinsing, washing PPEs and cleaning of operators?	

	MITIGATION ACTIONS	FINDINGS		COMMENTS/ RECOMMENDED ACTIONS	COMPLETION DATE (IF APPLICABLE)
		Yes	No		
11	Is there a storage space for clean non-working clothes and are changing areas available to put on work clothes?				

Evaporation tanks (DDT and other non-biodegradable chemical waste)

1	Is the evaporation tank for DDT liquid waste well built, is it located away from water bodies and is the tank covered with wire mesh?	Yes	No NA	Located downward side of rinse area? Constructed of concrete? Sunk into the ground with sides raised 20–30 cm high? Covered with mesh wire?	
2	Is there any cover available in the event of rain?	Yes	No NA	<i>Could be permanent shelter or temporary tarpaulins</i>	
3	Are the washing areas properly sloped to drain to evaporation tank, with no leaks or cracks?	Yes	No NA	No leaks No cracks	

Additional comments

IRS Supervision Inspection Checklist 2

Spraying activities inspection

Date of inspection: /...../.....

Country:

District:

County:

Village:

GPS coordinates:

Inspectors:

Field site office / district storage facility

	MITIGATION ACTIONS	FINDINGS		COMMENTS/ RECOMMENDED ACTIONS	TIMELINE FOR ACTIONS (IF APPLICABLE)
1	Are first aid kits for the storeroom and for transport vehicles stocked with pain killers (e.g. aspirin, panadol), dressings (e.g. plasters, gauze, tape, bandages) and eye wash?	Yes	No	Number of transport vehicles expected to be used Number of fully stocked first aid kits	
2	Is there someone trained in first aid, specifically in treating pesticide exposure?	Yes	No		
3	Are the store keeper, spray operators and wash persons properly instructed to wear PPE and do they wear appropriate PPE?	Yes	No	Instructed or trained to wear PPE? Do they wear appropriate PPE?	
4	Do spray teams have clean and complete PPE at the start of each work day?	Yes	No		
5	Are overalls washed daily at site and are they dried over the soak pit?	Yes	No		
6	When conveying equipment to the field, are all spray operators comfortably seated in vehicles with pumps well placed between their legs?	Yes	No		
7	Are the spray operators given a meal at the beginning of their workday?	Yes	No	<i>Meal should be provided if the spray operation is expected to last longer than 8 hours a day</i>	
8	Do any of the female spray operators appear to be pregnant or breast feeding?	Yes	No	Records for pregnancy test results observed on site? Plans to do pregnancy test midway during spray season? <i>Pregnant or breastfeeding female spray operators should be assigned tasks other than spraying</i>	
9	Is the “first in – first out” principle of insecticide use applied?	Yes	No	<i>Oldest inventory pesticides should be used first before reaching expiry date</i>	

	MITIGATION ACTIONS	FINDINGS		COMMENTS/ RECOMMENDED ACTIONS	TIMELINE FOR ACTIONS (IF APPLICABLE)
10	Is the store well-arranged (including the height of arranged items, allowance for free movement, proper stacking of items, appropriate ventilation)?	Yes	No		
11	Are warning signs and appropriate hazard labels correctly displayed (danger signs, insecticide safety notices)?	Yes	No		
12	Is a functional in-date fire extinguisher and other firefighting equipment available?	Yes	No		
13	Is there a thermometer to measure daily temperature in the store?	Yes	No		
14	Is the floor impermeable?	Yes	No		
15	If flood risk is unavoidable, what precautions have been taken to mitigate this fact?	Yes	No	1) Raised storage area 2) Proper drainage in place	
16	Is the roof leak-proof?	Yes	No		
17	Are lighting and ventilation adequate?	Yes	No	Is there visibility in the store day and night? Are there windows that can be easily opened? Are ventilators [e.g. fans, air conditioners] available to allow air circulation?	
18	Are the surroundings of the store and soak pit clear of IRS solid wastes (empty sachets, masks, gloves)?	Yes	No		
19	Is the spray team deployed with an adequate number of pumps, including spare nozzles?	Yes	No		
20	Are all pumps fitted with a CFV?	Yes	No	If <u>no</u> , any plans to procure CFV?	

Spray can preparation

1	Are the pumps filled using water from the previous day's progressive rinse?	Yes	No		
2	When the contents are mixed in the tank, is the tank shaken before being pressurized?	Yes	No		
3	Is the pump pressurized to 4 bar (58 psi)?	Yes	No		

	MITIGATION ACTIONS	FINDINGS	COMMENTS/ RECOMMENDED ACTIONS	TIMELINE FOR ACTIONS (IF APPLICABLE)
--	--------------------	----------	----------------------------------	--

Information dissemination and household preparation before spraying commences

1	Have the residents been instructed on what to do during and after the spraying operation?	Yes	No	Instructed to exclude animals from the house, to keep the house locked up for a specified duration post-spray, the importance of ventilation after the lock up period, proper disposal of dead insects, etc.	
2	Have all residents been informed that if they have any reaction such as skin irritation, they should wash the affected area with soap and clean water and seek medical attention if the symptoms persist?	Yes	No		
3	Have all personal belongings, animals, sick persons, food/ water items and eating utensils been removed from the house?	Yes	No		
4	Have all immovable items been properly covered with polythene sheets?	Yes	No		

Observation of spray operators and adequacy of supervision in the field

1	Do spray operators correctly record household details?	Yes	No		
2	Are spray operators in full PPE (hat/helmet, faceshield, overalls, boots, gloves and nose mask)?	Yes	No	If some spray operators are not in full PPE, what are the missing items? Is there a plan to replace missing items?	
3	Is the mixing of the insecticide witnessed by household residents?	Yes	No	<i>Residents should witness mixing as a way to confirm that the insecticide is being used for spraying</i>	
4	When liquid insecticide is used, are spray operators rinsing (x3) the bottle and adding rinsate to the pump?	Yes	No NA		
5	Are spray operators spraying only the recommended surfaces?	Yes	No		
6	Do spray operators correctly apply spraying techniques?	Yes	No	<i>Operator should maintain the nozzle tip 45 cm from the wall, use vertical swaths, ensure a swath overlap of 5 cm, shake the pump can and observe the pressure gauge</i>	

	MITIGATION ACTIONS	FINDINGS		COMMENTS/ RECOMMENDED ACTIONS	TIMELINE FOR ACTIONS (IF APPLICABLE)
7	Are any spray operators observed eating/drinking/smoking while at work?	Yes	No		
8	If spray operations last longer than 6 hours, is there a plan for spray operators to wash and drink water during a break?	Yes	No		
9	Is there adequate supervision during the operation?	Yes	No	1) Are supervisors alongside spray operators to monitor spray progress? 2) Is proper use of PPE observed? 3) Are supervisors cross checking spray operators data forms?	

Spray operators after spraying operations

1	At the end of the shift are both full and empty sachets/bottles returned, counted and recorded?	Yes	No		
2	Are empty sachets/bottles and used masks stored in separate designated and labelled containers in the store?	Yes	No		
3	Are 7 barrels for triple rinsing placed and arranged on impermeable ground or on a polythene sheet (in the case of permeable ground) along the wash bay?	Yes	No		
4	Do barrels #2, 4 and 6 contain enough water for triple rinsing?	Yes	No		
5	Are pump leftovers emptied into barrel #1 and stored properly for the next day's use?	Yes	No		
6	Do spray operators correctly conduct triple rinsing of pumps while wearing PPE?	Yes	No		
7	Are all used hand gloves, nose masks and empty sachets/bottles separated and consolidated in a waste storage room at the end of the day's work?	Yes	No		

	MITIGATION ACTIONS	FINDINGS		COMMENTS/ RECOMMENDED ACTIONS	TIMELINE FOR ACTIONS (IF APPLICABLE)
8	Are all overalls, face towels and other cloth PPE handed over to the store keeper for washing?	Yes	No		
9	Are washed pumps arranged in the store in an orderly fashion?	Yes	No		
10	Do spray teams have access to end-of-day washing facilities (including soap and water)?	Yes	No	Is there adequate clean water available for washing? ; Is soap available for washing?	
11	Do spray operators complete daily report forms (structures sprayed, stock received, used and returned) ?	Yes	No	Are supervisors cross-checking data forms filled in by spray operators?	
12	Is the insecticide usage rate and average number of houses sprayed per spray operator within acceptable limits? <i>(At least 4–8 sachets and 10 houses/spray operator/day)</i>	Yes	No		

Additional comments

IRS Supervision Inspection Checklist 3

Post-spraying activities, wash up and waste disposal

Date of inspection: /...../.....

Country:

District:

County:

Village:

GPS coordinates:

Inspectors:

Observations on spray operation on arriving at field station / wash-up facility / progressive rinse

	MITIGATION ACTIONS	FINDINGS		COMMENTS/ RECOMMENDED ACTIONS	TIMELINE FOR ACTIONS (IF APPLICABLE)
1	Is the wash site located near the field station/district storage facility?	Yes	No		
2	Are all spray operators wearing PPE when they return from spraying?	Yes	No		
3	Are all persons conducting the progressive rinse in full PPE?	Yes	No		
4	Are all wash persons wearing appropriate PPE?	Yes	No		
5	Are any spray operators eating, drinking or smoking?	Yes	No		
6	Are the #2, 4 and 6 wash tanks filled with water?	Yes	No		
7	Are spray pumps triple rinsed using the progressive rinse method?	Yes	No	Is the insecticide poured into tank #1 used for spraying the following day? If rinse in other drums is kept clean, is the water used to reconstitute insecticides? <i>Note: Pesticides poured into tank #1 can be used for spraying the following day. If rinse in other drums is kept clean, then the water can be used to reconstitute insecticide</i>	
8	Are the outsides of the tanks rinsed off in the soak pit?	Yes	No		
9	Are the helmets and face shields rinsed off in the soak pit?	Yes	No		
10	Are PPEs washed and then hung to dry over the soak pit or soak away?	Yes	No		
11	Are soak pits or evaporation tanks used to dispose of all contaminated water?	Yes	No		

	MITIGATION ACTIONS	FINDINGS		COMMENTS/ RECOMMENDED ACTIONS	TIMELINE FOR ACTIONS (IF APPLICABLE)
12	Are the pump nozzles, filters and strainers cleaned with a soft (tooth) brush and water to remove particulates?	Yes	No		
13	Are the spray pumps hung upside down to dry?	Yes	No	<i>Spray pumps should be hung upside down after being washed</i>	

Solid waste

1	Are empty sachets/ bottles inventoried and documented?	Yes	No		
2	Are all contaminated empty sachets/bottles (leaked and damaged containers) repacked and labelled appropriately, and put in storage?	Yes	No	<i>Not thrown on the ground, or buried or burned in an open pit</i>	
3	Are contaminated mouth/ nose masks stored with empty sachets?	Yes	No	Are chemical waste stored in a separate room?	
4	Are any other contaminated materials (e.g. cardboard, materials for cleaning spills) placed in a container?	Yes	No NA	If <u>no</u> , is there a plan in place?	
5	Have wornout and contaminated PPE that cannot be reused been cleaned and disposed of together with other waste materials?	Yes	No NA	If <u>no</u> , is there a plan in place?	
6	Have DDT sachets been incinerated at a certified facility?	Yes	No NA	If <u>no</u> , has such a facility been identified?	

Effluent waste soak pit (biodegradable insecticides, e.g. pyrethroid)

1	Is the soak pit located away from bodies of water or from flood prone areas?	Yes	No	Is the soak pit at least 100 m from water body?	
2	If located on a slope, is there a berm to prohibit run-off from entering on the uphill side, and one on the downhill side to contain effluent run-off?	Yes	No		
3	Is the soak pit absorbing all the effluent waste?	Yes	No		

	MITIGATION ACTIONS	FINDINGS		COMMENTS/ RECOMMENDED ACTIONS	TIMELINE FOR ACTIONS (IF APPLICABLE)
4	Is a puddle and/or run-off being created?	Yes	No		
5	Is there adequate gravel to act as a filter?	Yes	No	Is the soak pit surface clear of soil and vegetation?	
6	Is the soak pit area fenced and gated?	Yes	No	<i>Fence needed to keep children and animals out</i>	
7	Is there a danger sign and appropriate hazard labelling at the soak pit to keep out unauthorized persons?	Yes	No	If <u>no</u> , has there been adequate communication with the community so they understand not to enter the wash areas?	

Effluent wastes evaporation tanks (DDT and other non-biodegradable chemicals)

1	Are evaporation tanks located away from bodies of water or flood prone areas?	Yes	No	<i>Evaporation tank should be at least 100 m from water body</i>	
2	If located on a slope, is there a berm to prohibit run-off from entering on the uphill side, and one on the downhill side to contain effluent run-off?	Yes	No		
3	Are there cracks visible in the concrete?	Yes	No	If yes, is there a plan to seal the cracks to avoid seepage into the soil?	
4	Are there signs of evaporation?	Yes	No	Are traces of dried residual on the side of the tank above water visible?	
5	If not, do you see effluent contained safely elsewhere? (e.g. in polythene tanks)	Yes	No		
6	Is there any cover available in the event of rain?	Yes	No	<i>Could be permanent shelter or temporary tarpaulins</i>	
7	Is the evaporation tank fenced off and gated?	Yes	No	<i>To keep out children and animals</i>	
8	Is there a danger sign and appropriate hazard labelling at the evaporation pit to keep out unauthorized persons?	Yes	No	If <u>no</u> , has there been communication with community so they understand not to enter the wash areas?	

Effluent waste wash areas

1	Is there a concrete catchment area or tarpaulin spread out on the ground to catch all effluent?	Yes	No		
2	Can all effluent be easily drained into a soak pit or evaporation tank?	Yes	No		

	MITIGATION ACTIONS	FINDINGS		COMMENTS/ RECOMMENDED ACTIONS	TIMELINE FOR ACTIONS (IF APPLICABLE)
3	Are the overalls hung out to dry on clothes lines over the wash area?	Yes	No		
4	Is the wash area fenced off and gated?	Yes	No	<i>To keep out children and animals</i>	
5	Is there a danger sign and hazard labelling at the evaporation pit to keep out unauthorized persons?	Yes	No	If <u>no</u> , has there been communication with community so they understand dangers and that they must not enter wash areas?	

Additional comments

For more information, please contact:

Vector Control Unit
Global Malaria Programme
20 Avenue Appia
1211 Geneva 27
Switzerland

infogmp@who.int
<http://www.who.int/malaria>

ISBN 978 92 4 150894 0



9 789241 508940